

Z125 PRO

Motorcycle

OWNER'S MANUAL

 Read this manual carefully. It contains safety information.

 **WARNING**

Operating, servicing and maintaining a passenger vehicle or off-road vehicle can expose you to chemicals including engine exhaust, carbon monoxide, phthalates, and lead, which are known to the State of California to cause cancer and birth defects or other reproductive harm. To minimize exposure, avoid breathing exhaust, do not idle the engine except as necessary, service your vehicle in a well-ventilated area and wear gloves or wash your hands frequently when servicing your vehicle. For more information go to www.P65warnings.ca.gov/passenger-vehicle.

For more information about safe riding (Movie and/or Booklets) on your Kawasaki products, please scan this QR with your camera equipped mobile device or visit this website at <https://www.kawasaki.com/en-us/owner-center/safety-resources>



Quick Reference Guide

This Quick Reference Guide will assist you in finding the information you're looking for.

SAFETY INFORMATION

GENERAL INFORMATION

HOW TO RIDE THE MOTORCYCLE

MAINTENANCE AND ADJUSTMENT

APPENDIX

MAINTENANCE RECORD

A Table of Contents is included after the Foreword.

Whenever you see the symbols shown below, heed their instructions! Always follow safe operating and maintenance practices.

 **DANGER**

DANGER indicates a hazardous situation which, if not avoided, will result in death or serious injury.

 **WARNING**

WARNING indicates a hazardous situation which, if not avoided, could result in death or serious injury.

NOTICE

NOTICE is used to address practices not related to personal injury.

NOTE

- *NOTE* indicates information that may help or guide you in the operation or service of the vehicle.

NOTICE

**THIS PRODUCT HAS BEEN
MANUFACTURED FOR USE IN A
REASONABLE AND PRUDENT
MANNER BY A QUALIFIED OP-
ERATOR AND AS A VEHICLE
ONLY.**

Foreword

Congratulations on your purchase of a new Kawasaki motorcycle. Your new motorcycle is the product of Kawasaki's advanced engineering, exhaustive testing, and continuous striving for superior reliability, safety and performance.

Please read this Owner's Manual carefully before riding so that you will be thoroughly familiar with the proper operation of your motorcycle's controls, its features, capabilities, and limitations. This manual offers many safe riding tips, but its purpose is not to provide instruction in all the techniques and skills required to ride a motorcycle safely. Kawasaki strongly recommends that all operators of this vehicle enroll in a motorcycle rider training program to attain awareness of the mental and physical requirements necessary for safe motorcycle operation.

To ensure a long, trouble-free life for your motorcycle, give it the proper care and maintenance described in this manual. For those who would like more detailed information on their Kawasaki Motorcycle, a Service Manual is available for purchase from any authorized Kawasaki motorcycle dealer. The Service Manual contains detailed disassembly and maintenance information. Those who plan to do their own work should, of course, be competent mechanics and possess the special tools described in the Service Manual.

Keep this Owner's Manual aboard your motorcycle at all times so that you can refer to it whenever you need information.

This manual should be considered a permanent part of the motorcycle and should remain with the motorcycle when it is sold.

All rights reserved. No part of this publication may be reproduced without our prior written permission.

This publication includes the latest information available at the time of printing. However, there may be minor differences between the actual product and illustrations and text in this manual.

All products are subject to change without prior notice or obligation. Any updated information is available in the on-line Owner's Manual on Kawasaki's website.

[Owner's Manual]

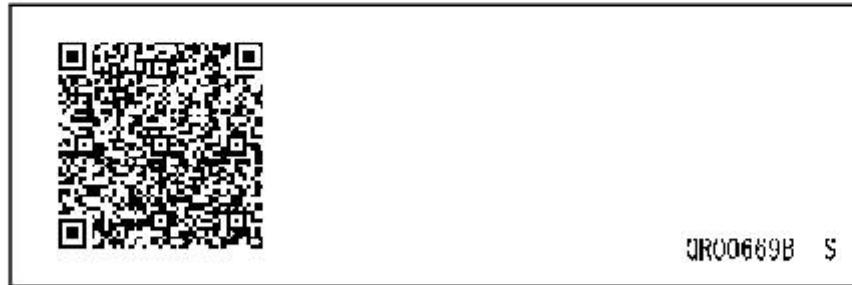

KAWASAKI MOTORS, LTD.

Emission Control Information

To protect the environment in which we all live, Kawasaki has incorporated crankcase emission (1) and exhaust emission (2) control systems in compliance with applicable regulations of the United States Environmental Protection Agency and California Air Resources Board. Additionally, Kawasaki has incorporated an evaporative emission control system (3) in compliance with applicable regulations of the United States Environmental Protection Agency and California Air Resources Board.

1. Crankcase Emission Control System

This system eliminates the release of crankcase vapors into the atmosphere. Instead, the vapors are routed through an oil separator to the intake side of the engine. While the engine is operating, the vapors are drawn into the combustion chamber, where they are burned along with the fuel and air supplied by the fuel injection system.

2. Exhaust Emission Control System

This system reduces the amount of pollutants discharged into the atmosphere by the exhaust of this motorcycle. The fuel, ignition and exhaust systems of this motorcycle have been carefully designed and constructed to ensure an efficient engine with low exhaust pollutant levels. The exhaust system of this model motorcycle includes a catalytic converter system.

3. Evaporative Emission Control System

The evaporative emission control system for this vehicle consists of low permeation fuel hoses and fuel tank.

3. Evaporative Emission Control System (California)

Vapors caused by fuel evaporation in the fuel system are not vented into the atmosphere. Instead, fuel vapors are routed into the running engine to be burned, or stored in a canister when the engine is stopped.

High Altitude Performance Adjustment Information

High Altitude adjustment is not required.

Maintenance and Warranty

Proper maintenance is necessary to ensure that your motorcycle will continue to have low emission levels. This Owner's Manual contains those maintenance recommendations for your motorcycle. Those items identified by the Periodic Maintenance Chart are necessary to ensure compliance with the applicable standards.

As the owner of this motorcycle, you have the responsibility to make sure that the recommended maintenance is carried out according to the instructions in this Owner's Manual at your own expense.

The Kawasaki Limited Emission Control System Warranty requires that you return your motorcycle to an authorized Kawasaki dealer for remedy under warranty. Please read the warranty carefully, and keep it valid by complying with the owner's obligations it contains.

You should keep a maintenance record for your motorcycle. To assist you in keeping this record, we have provided space on pages 145 through 149 of this manual where an authorized Kawasaki dealer, or someone equally competent, can record the maintenance. You should also retain copies of maintenance work orders, bills, etc., as verification of this maintenance.

Tampering With Noise Control System Prohibited

Federal law prohibits the following acts or the causing thereof: (1) the removal or rendering inoperative by any person other than for purposes of maintenance, repair, or replacement, of any device or element of design incorporated into any new vehicle for the purpose of noise control prior to its sale or delivery to the ultimate purchaser or while it is in use, or (2) the use of the vehicle after such device or element of design has been removed or rendered inoperative by any person.

Among those acts presumed to constitute tampering are the acts listed below:

- * Replacement of the original exhaust system or muffler with a component not in compliance with Federal regulations.
- * Removal of the muffler(s) or any internal portion of the muffler(s).
- * Removal of the air box or air box cover.
- * Modifications to the muffler(s) or air intake system by cutting, drilling, or other means if such modifications result in increased noise levels.

TABLE OF CONTENTS

SAFETY INFORMATION	15	GENERAL INFORMATION	27
Read Owner's Manual	15	Specifications	27
Training	15	Serial Number Locations	32
Daily Checks and Periodic Maintenance	15	Location of Labels	33
Loading and Accessories Information	16	Location of Parts	39
Passenger	17	Meter Instruments	42
Baggage and Luggage	18	Indicators	43
Accessories	18	Speedometer/Tachometer	47
Other Load	19	Display Setting	48
If You are Involved in an Accident....	20	Features	51
Safe Operation	20	Keys	53
Carbon Monoxide Hazard	20	Ignition Switch/Steering Lock	54
Fueling	21	Right Handlebar Switches	55
Never Ride with Drugs or Alcohol.	21	Left Handlebar Switches	56
Protective Gear and Clothing	21	Fuel	57
Safe Riding Techniques	22	Fuel Requirements	57
Additional Considerations for High Speed Operation	25	Filling the Tank	60
		Side Stand	63
		Seat	63
		Helmet Hook	65

Tool Kit	66	Brakes	107
Rear View Mirror	66	Brake Light Switches.....	110
Event Data Recorder.....	68	Suspension System	112
HOW TO RIDE THE MOTORCYCLE .	70	Front Fork	112
Break-In	70	Rear Shock Absorber	112
Starting the Engine	71	Setting Table.....	113
Moving Off.....	73	Wheels	114
Shifting Gears	73	Battery.....	117
Braking	75	Headlight.....	121
Stopping the Engine.....	76	Fuses	123
Stopping the Motorcycle in an		General Lubrication.....	124
Emergency	77	Cleaning	125
Parking	78	General Precautions	125
MAINTENANCE AND ADJUSTMENT	80	Where to be Careful	129
Daily Checks	82	Washing Your Vehicle	129
Periodic Maintenance.....	85	APPENDIX	131
Engine Oil	89	Storage	131
Spark Plug	93	Troubleshooting Guide.....	134
Air Cleaner	95	Your Warranty/Owner Satisfaction ...	136
Throttle Control System	99	Reporting Safety Defects	141
Idle Speed.....	101	Environmental Protection.....	142
Clutch.....	102	Location of DFI System Diagnostic	
Drive Chain	103	Connector	142

Vehicle Data Recordings..... 143

MAINTENANCE RECORD 145

SAFETY INFORMATION

Read Owner's Manual

Read this Owner's Manual carefully before riding so that you will be thoroughly familiar with the proper operation of your motorcycle's controls, its features, capabilities, and limitations. This manual offers many safe riding tips, but its purpose is not to provide instruction in all of the techniques and skills required to ride a motorcycle safely.

Training

Kawasaki strongly recommends that all operators of this vehicle complete a suitable motorcycle rider training program to learn the proper skills and techniques necessary for safe motorcycle operation.

Daily Checks and Periodic Maintenance

It is important to keep your motorcycle properly maintained and in safe riding condition. Inspect your motorcycle before every ride and carry out all periodic maintenance. See the Daily Checks section and the Periodic Maintenance section in the MAINTENANCE AND ADJUSTMENT chapter for more information.



WARNING

Failure to perform these checks or to correct a problem before operation may result in serious damage or an accident. Always perform daily checks before operation.

16 SAFETY INFORMATION

To ensure your motorcycle is serviced using the latest servicing information, it is recommended that an authorized Kawasaki Dealer performs the periodic maintenance as directed in the Owner's Manual.

If you notice any irregular operating condition, have your motorcycle thoroughly checked at an authorized Kawasaki dealer as soon as possible.

Loading and Accessories Information

WARNING

Incorrect loading, improper installation or use of accessories, or modification of your motorcycle may result in an unsafe riding condition. Before you ride the motorcycle, make sure it is not overloaded and that you have followed these instructions.

Maximum Load

Weight of rider, passenger, baggage, and accessories must not exceed 160 kg (353 lb).

With the exception of genuine Kawasaki Parts and Accessories, Kawasaki has no control over the design or application of accessories. In some cases, improper installation

or use of accessories, or motorcycle modification, will void the motorcycle warranty; can negatively affect performance, stability and safety; and can even be illegal.

In selecting and using accessories, and in loading the motorcycle, you are personally responsible for your own safety and the safety of other persons involved.

NOTE

○ *Kawasaki Parts and Accessories have been specially designed for use on Kawasaki motorcycles. We strongly recommend that all parts and accessories you add to your motorcycle be genuine Kawasaki components.*

Because a motorcycle is sensitive to changes in weight and aerodynamic forces, you must take extreme care in carrying cargo, passengers and/or in

fitting additional accessories. The following general guidelines have been prepared to assist you in making your determinations.

Passenger

1. Never carry more than one passenger.
2. The passenger should only sit on the pillion.
3. Any passenger should be thoroughly familiar with motorcycle operation. The passenger can affect control of the motorcycle by improper positioning during cornering and sudden movements. It is important that the passenger sits still while the motorcycle is in motion and not interfere with the operation of the motorcycle. Do not carry animals on your motorcycle.

18 SAFETY INFORMATION

4. Do not carry passengers unless passenger footpegs are installed. Instruct any passenger before riding to keep his or her feet on the passenger footpegs and hold on to the operator or seat strap. Do not carry a passenger unless he or she is tall enough to reach the footpegs with their feet.

Baggage and Luggage

1. All baggage should be carried as low as possible to reduce the effect on the motorcycle's center of gravity. Baggage weight should also be distributed equally on both sides of the motorcycle. Avoid carrying baggage that extends beyond the rear of the motorcycle.
2. Baggage should be securely attached. Make sure that the baggage

will not move around while you are riding. Recheck baggage security as often as possible (not while the motorcycle is in motion) and adjust as necessary.

3. Do not carry heavy or bulky items on a luggage rack. It is designed for light items, and overloading can affect handling due to changes in weight distribution and aerodynamic forces.

Accessories

1. Do not install accessories or carry baggage that impairs the performance of the motorcycle. Make sure that you have not adversely affected any lighting components, road clearance, banking capability (i.e., lean angle), control operation, wheel travel, front fork movement,

or any other aspects of the motorcycle's operation.

2. Weight attached to the handlebars or front fork will increase the mass of the steering assembly and can result in an unsafe riding condition.
3. Fairings, backrests, and other large items have the capability of adversely affecting stability and handling of the motorcycle, not only due to their weight, but also due to the aerodynamic force acting on these surfaces while the motorcycle is in operation. Poorly designed or installed items can result in an unsafe riding condition.

Other Load

1. This motorcycle is not intended to be equipped with a sidecar or to be used to tow any trailers or other vehicles. Kawasaki does not manufacture sidecars or trailers for motorcycles and cannot predict the effects of such accessories on handling or stability, but can only warn that the effects can be adverse and that Kawasaki cannot assume responsibility for the results of such unintended use of the motorcycle.
2. Furthermore, any adverse effects on motorcycle components caused by the use of such accessories will not be remedied under warranty.

20 SAFETY INFORMATION

If You are Involved in an Accident

Make sure of your own safety first. Determine the severity of any injuries and call for emergency assistance if needed. Always follow applicable laws and regulations if any other person, vehicle or property is involved.

Do not attempt to continue riding without first evaluating your motorcycle's condition. Inspect for fluid leaks, check critical nuts and bolts, and check the handlebars, control levers, brakes, and wheels for damage and proper function. Ride slowly and cautiously - your motorcycle may have suffered damage that is not immediately apparent. Have your motorcycle thoroughly checked at a Kawasaki dealer as soon as possible.

Safe Operation

The following should be carefully observed for safe and effective vehicle operation.

Carbon Monoxide Hazard

DANGER

Exhaust gas contains carbon monoxide, a colorless, odorless poisonous gas. Inhaling carbon monoxide can cause serious brain injury or death. DO NOT run the engine in enclosed areas. Operate only in a well-ventilated area.

Fueling

 **WARNING**

Gasoline is extremely flammable and can be explosive under certain conditions.

To avoid a possible fire or explosion, turn the ignition switch off. Do not smoke. Make sure the area is well ventilated and free from any source of flame or sparks; this includes any appliance with a pilot light.

Never Ride with Drugs or Alcohol

Alcohol and drugs impair your judgment and reaction time. Never consume alcohol or drugs before or while riding motorcycles.

Protective Gear and Clothing

Helmet

Kawasaki strongly recommends both the operator and passenger wear a helmet even if this is not a legal requirement.

- Make sure that your helmet fits correctly and is properly fastened.
- Choose a motorcycle helmet that meets the safety standards applicable to your country. Ask your motorcycle dealer to advise you if necessary.

22 SAFETY INFORMATION

Eye Protection

Always use eye protection. If your helmet does not have a visor installed, wear goggles.

Gloves

Wear gloves which have suitable protection for your hands, especially against abrasion.

Clothing

Wear the riding wear which have protectors for each parts of the body (chest, shoulders, back, elbows and knees, etc.) as much as possible, or wear protectors for them.

- Always wear a long-sleeved jacket and long trousers which are abrasion resistant and keep you warm.
- Wear clothing that allows freedom of movement.
- Avoid wearing clothes which have loose cuffs or other fastenings

which could interfere with the controls of your motorcycle.

- Wear bright, highly visible clothing.

Boots

Wear proper protective boots that fit properly and do not interfere with gear shifting or braking.

Safe Riding Techniques

Keep Hands on Handlebars

When riding always keep both hands on the handlebars and both feet on the footpegs. Removing your hands from the handlebars or feet from the footpegs while riding can be hazardous. If you remove even one hand or foot, you reduce your ability to control the motorcycle.

Look Over Your Shoulder

Before changing lanes, look over your shoulder to make sure the way is clear. Do not rely solely on the rear view mirror; you may misjudge a vehicle's distance and speed, or you may not see it at all.

Accelerate and Brake Smoothly

In general your actions should be smooth as sudden acceleration, braking or turning may cause loss of control, especially when riding in wet conditions or on loose road surfaces, when the ability to maneuver will be reduced.

Select Correct Gear Speeds

When going up steep slopes, shift to a lower gear so that there is power to spare rather than overloading the engine.

Use Both Front and Rear Brakes

When applying the brakes, use both the front and rear brakes. Applying only one brake for sudden braking may cause the motorcycle to skid and lose control.

Use Engine Brake

When going down long slopes, help control vehicle speed by closing the throttle so that the engine can act as an auxiliary brake. Use the front and rear brakes for primary braking.

Riding in Wet Conditions

Rely more on the throttle to control vehicle speed and less on the front and rear brakes. The throttle should also be used judiciously to avoid skidding the rear wheel from too rapid acceleration or deceleration.

Braking performance is also reduced in wet conditions. Carefully ride at a

24 SAFETY INFORMATION

slow speed and apply the brakes several times to help dry and restores them to normal operating performance.

Lubricate the drive chain after wet-weather riding to prevent rust and corrosion.

Ride Prudently

Riding at the proper speed and avoiding unnecessarily fast acceleration are important not only for safety and low fuel consumption but also for long vehicle life and quieter operation.

Riding on Rough Roads

Exercise caution, slow down, and grip the fuel tank with the knees for better stability.

Acceleration

When quick acceleration is necessary to pass another vehicle, shift to a lower gear to obtain the necessary power.

Downshifting

To avoid engine damage and rear wheel lock-up do not downshift at high rpm.

Avoid Unnecessary Weaving

Unnecessary weaving jeopardizes the safety of both the rider and other motorists.

Additional Considerations for High Speed Operation



WARNING

Handling characteristics of a motorcycle at high speeds may vary from those you are familiar with at legal highway speeds. Do not attempt high speed operation unless you have received sufficient training and have the required skills. Do not operate at high speeds on public roads.

Brakes

The importance of the brakes, especially during high speed operation, cannot be overemphasized. Check to

see that they are correctly adjusted and functioning properly.

Steering

Looseness in the steering can cause loss of control. Check to see that the handlebars turns freely but has no play.

Tires

High speed operation is hard on tires, and good tires are crucial for safe riding. Examine their overall condition, inflate them to the proper pressure, and check the wheel balance.

Fuel

Have sufficient fuel for the high fuel consumption during high speed operation.

Engine Oil

To avoid engine seizure and resulting loss of control, make sure that the oil level is at the upper level line on the dipstick.

26 SAFETY INFORMATION

Electrical Equipment

Make sure that the headlight, tail/brake light, turn signals, horn, etc., all work properly.

Miscellaneous

Make sure that all nuts and bolts are tight and that all safety related parts are in good condition.

GENERAL INFORMATION

Specifications

PERFORMANCE

Minimum Turning Radius 2.3 m (7.5 ft)

DIMENSIONS

Overall Length 1 700 mm (66.93 in.)

Overall Width 750 mm (29.5 in.)

Overall Height 1 005 mm (39.57 in.)

Wheelbase 1 175 mm (46.26 in.)

Road Clearance 155 mm (6.10 in.)

Curb Mass 102 kg (225 lb)

ENGINE

Type SOHC, single-cylinder, 4-stroke, air-cooled

Displacement 125 cm³ (7.63 cu in.)

Bore × Stroke 56.0 × 50.6 mm (2.20 × 1.99 in.)

Compression Ratio 9.8:1

28 GENERAL INFORMATION

Starting System		Electric starter
Fuel System		FI (Fuel Injection)
Ignition System		Battery and coil (transistorized ignition)
Ignition Timing (Electronically advanced)		0° BTDC @1 800 r/min (rpm) – 37° BTDC @8 000 r/min (rpm)
Spark Plug:	Type	NGK CR6HSA
	Gap	0.6 – 0.7 mm (0.024 – 0.028 in.)
Lubrication System		Forced lubrication (wet sump)
Engine Oil:	Type	API SG, SH, SJ, SL or SM with JASO MA, MA1 or MA2
	Viscosity	SAE 10W-40
	Capacity	1.0 L (1.1 US qt)

TRANSMISSION

Transmission Type	4-speed, constant mesh, return shift
Clutch Type	Wet, multi disc
Driving System	Chain drive
Primary Reduction Ratio	3.409 (75/22)

Final Reduction Ratio		2.143 (30/14)
Overall Drive Ratio		7.940 (Top gear)
Gear Ratio:	1st	3.000 (36/12)
	2nd	1.938 (31/16)
	3rd	1.350 (27/20)
	4th	1.087 (25/23)

FRAME

Caster		26.0°
Trail		69 mm (2.7 in.)
Tire Size:	Front	100/90-12 49J
	Rear	120/70-12 51L
Rim Size:	Front	12 × MT2.50
	Rear	12 × MT3.50
Fuel Tank Capacity		7.4 L (2.0 US gal)
Brake Fluid:	Front	DOT3 or DOT4
	Rear	DOT3

30 GENERAL INFORMATION

ELECTRICAL EQUIPMENT

Battery		12 V 3 Ah (10 HR)
Headlight:	High Beam	12 V 35 W
	Low Beam	12 V 35 W
Brake/Tail Light		LED

Even if one of LED (Light Emitting Diode) brake/tail light does not go on, consult with an authorized Kawasaki dealer.

Brake/Tail Light

The brake/tail light goes on as below.

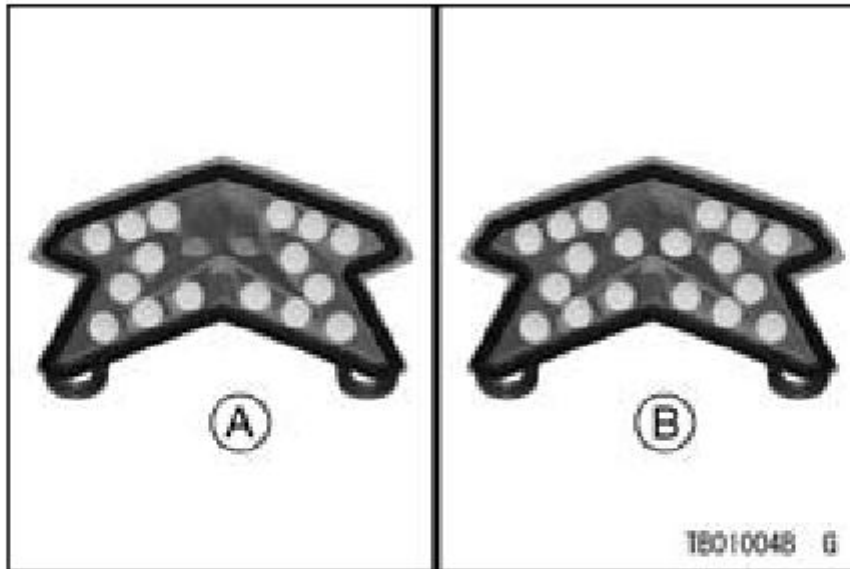

A. When the ignition switch is turned on.

B. When the brakes are applied.

When the ignition switch is turned on, some LED does not go on, however, it is normal.

Specifications are subject to change without notice.

Serial Number Locations

The engine and frame serial numbers are used to register the motorcycle. They are the only means of identifying your particular machine from others of the same model type. These serial numbers may be needed by your dealer when ordering parts. In the event of theft, the investigating authorities will require both numbers as well as the model type and any peculiar features of your machine that can help them identify it.

Engine No.

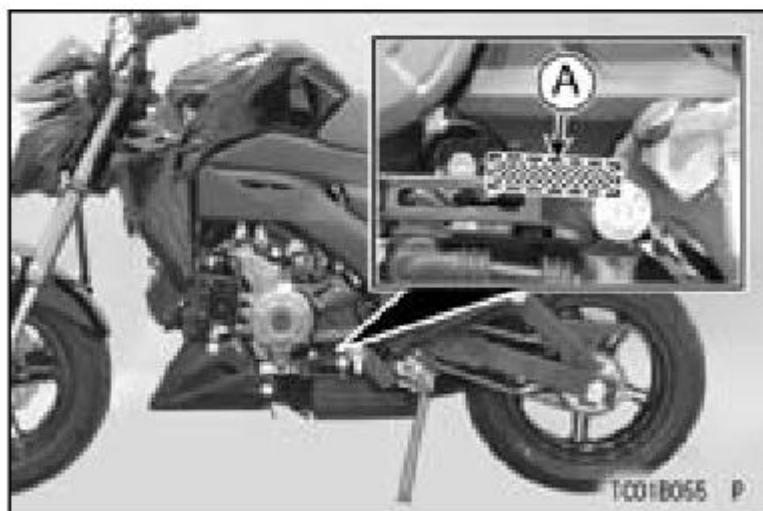

A. Engine Number

Frame No.



A. Frame Number

Location of Labels

All warning labels which are on your vehicle are repeated here. Read labels on your vehicle and understand them thoroughly. They contain information which is important for your safety and the safety of anyone else who may operate your vehicle. Therefore, it is very important that all warning labels be on your vehicle in the locations shown. If any label is missing, damaged, or worn, get a replacement from your Kawasaki dealer and install it in the correct position.

NOTE

- *Refer to the actual vehicle label for model specific data grayed out in the illustration.*

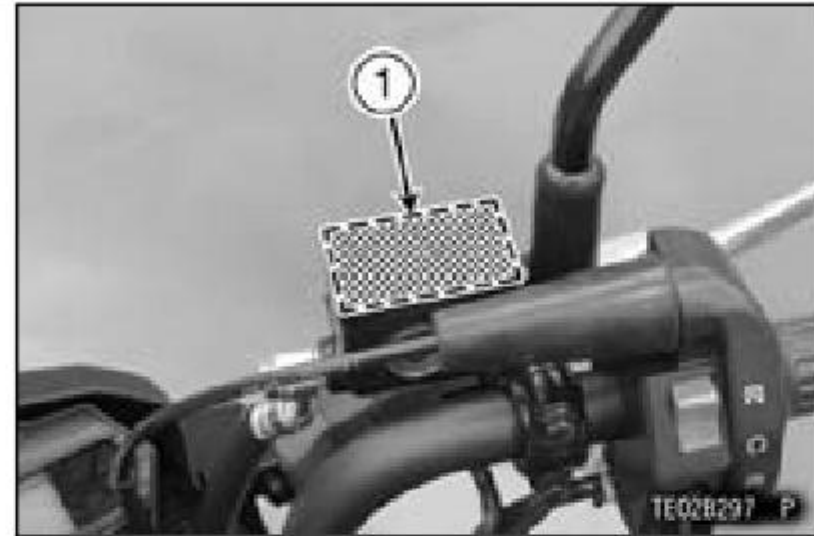

1. Brake Fluid (Front)

34 GENERAL INFORMATION

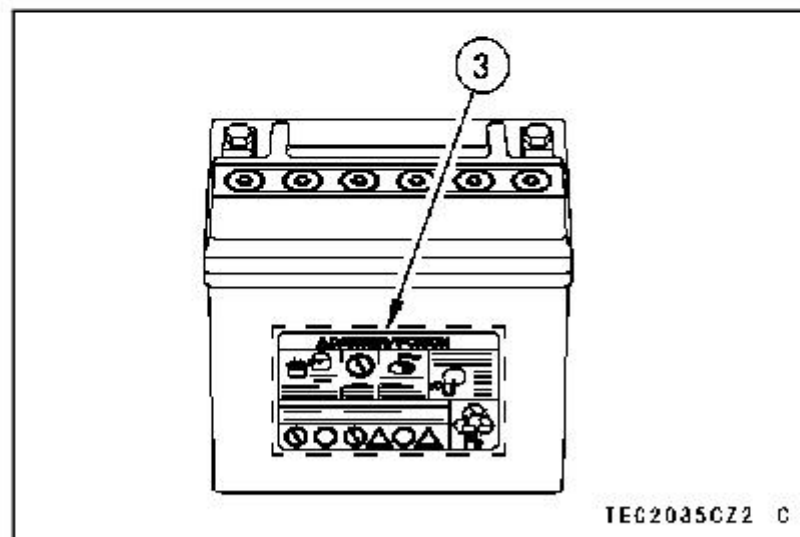
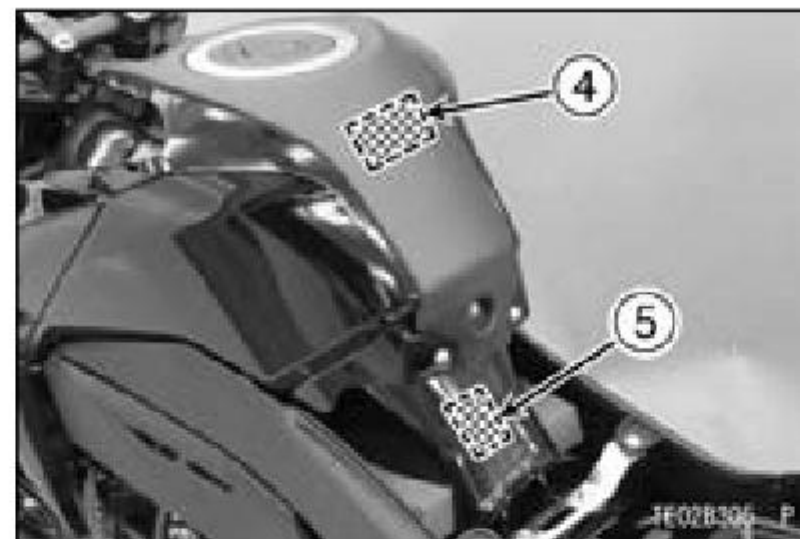

- 2. Brake Fluid (Rear)
- 3. Battery Poison/Danger
- *4. Fuel Level
- 5. Vehicle Emission Control Information

*: only on California model

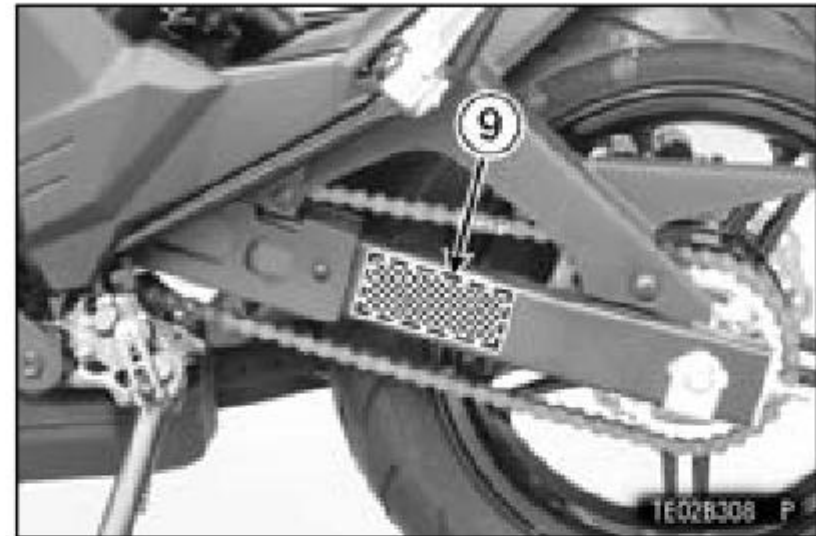
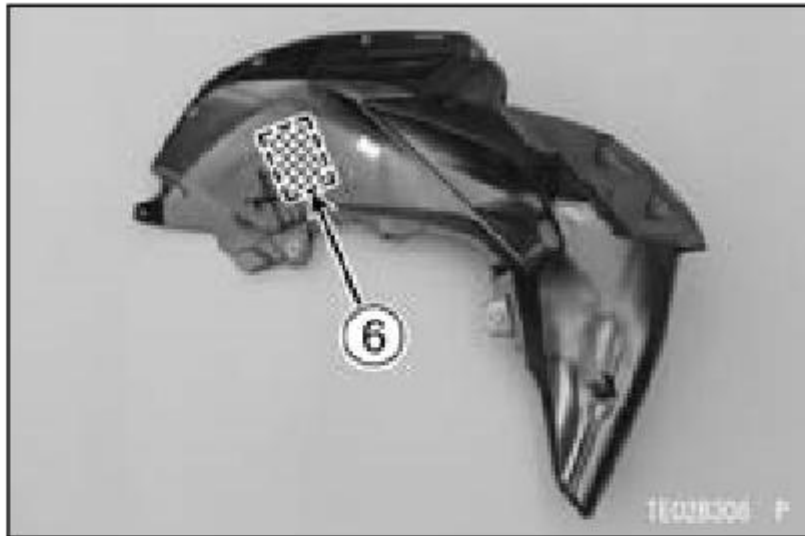

- *6. Vacuum Hose Routing Diagram
- 7. Tire and Load Data
- 8. Noise Emission Control Information
- 9. Important Drive Chain Information

*: only on California model

36 GENERAL INFORMATION

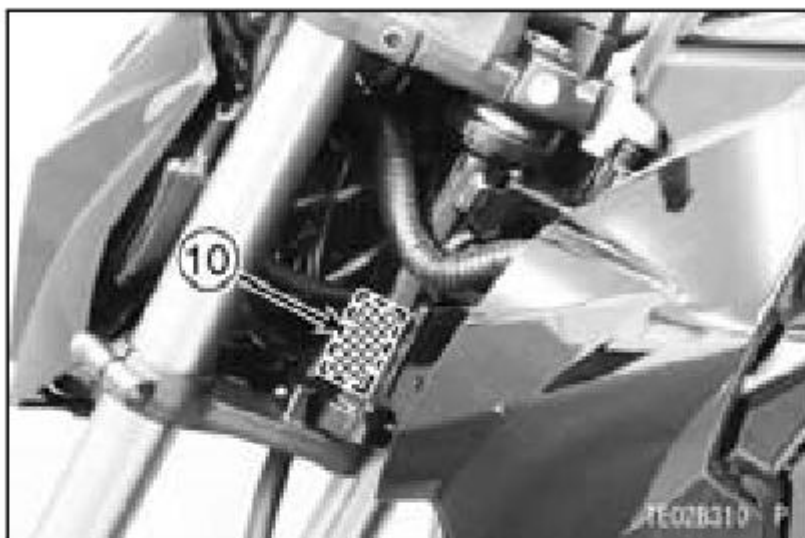

10. Weight and Manufacture

1)

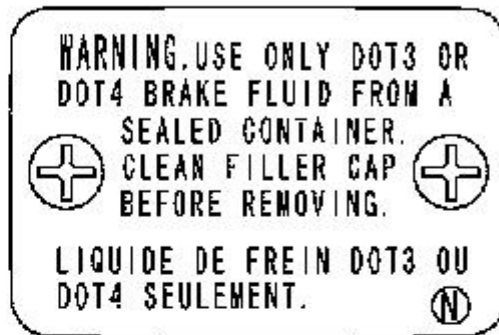

TE03925CN9 C

3)



TE03508D S

2)



TE03675E S

38 GENERAL INFORMATION

7)

WARNING		TIRE AND LOAD DATA			
	Air Pressure (Cold)	Size & Make (See Tubeless Tire)	Minimum Tread Depth		
Front	150 kPa (1.50 kg/cm ² , 22 psi)	P18 180/50R12 85T70	1 mm (0.04 in)		
Rear	200 kPa (2.00 kg/cm ² , 29 psi)	P18 180/50R12 85T70	Up to 130 km/h (80 MPH)	2 mm (0.08 in)	
			Over 130 km/h (80 MPH)	3 mm (0.12 in)	

Use of tires with improper inflation or excessive wear, unsuitable replacement tires or overloading can result in a loss of control causing serious bodily injury. See Owner's Manual for additional information.

TE03411F S

Location of Parts

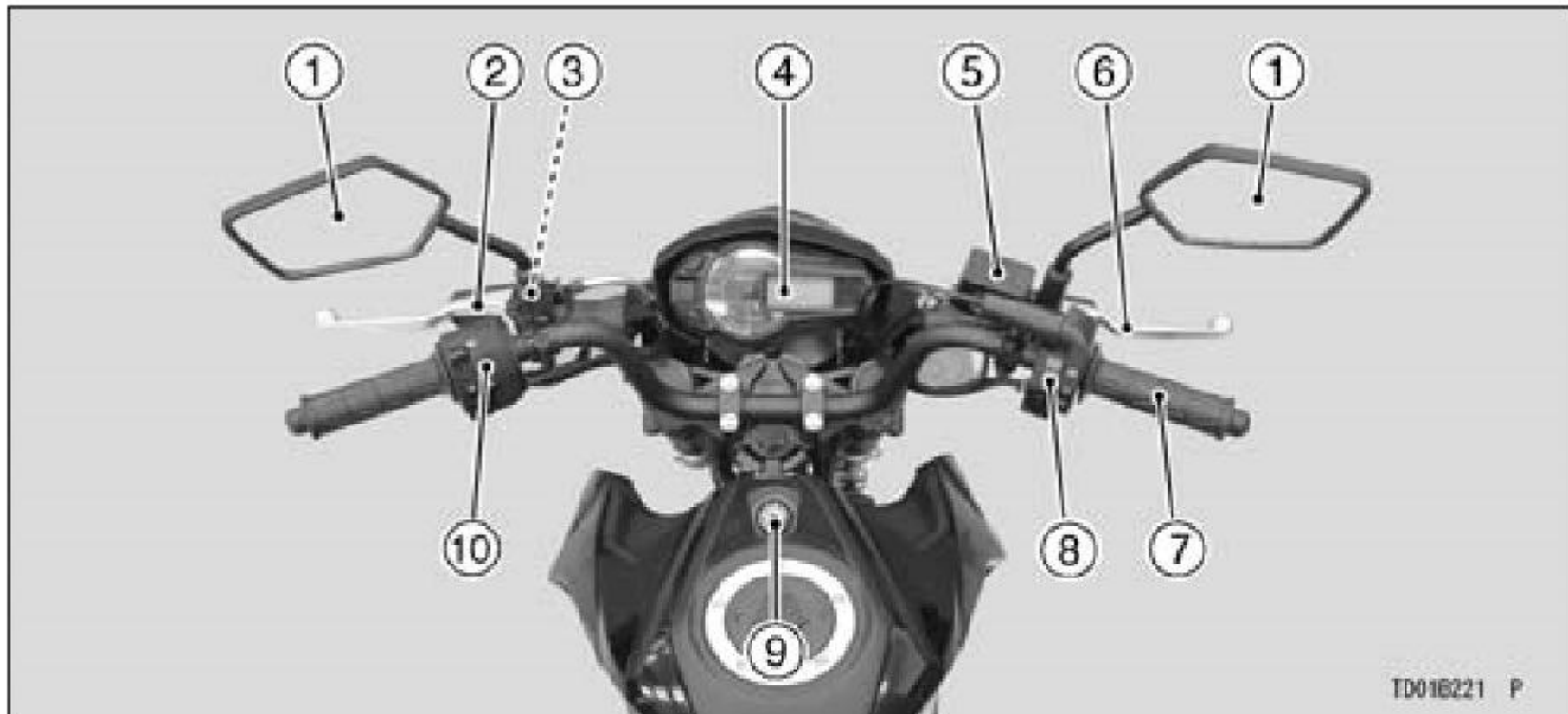

TD016221 P

1. Rear View Mirrors
2. Clutch Lever
3. Starter Lockout Switch
4. Meter Instruments
5. Brake Fluid Reservoir (Front)

6. Front Brake Lever
7. Throttle Grip
8. Right Handlebar Switches
9. Ignition Switch/Steering Lock
10. Left Handlebar Switches

40 GENERAL INFORMATION

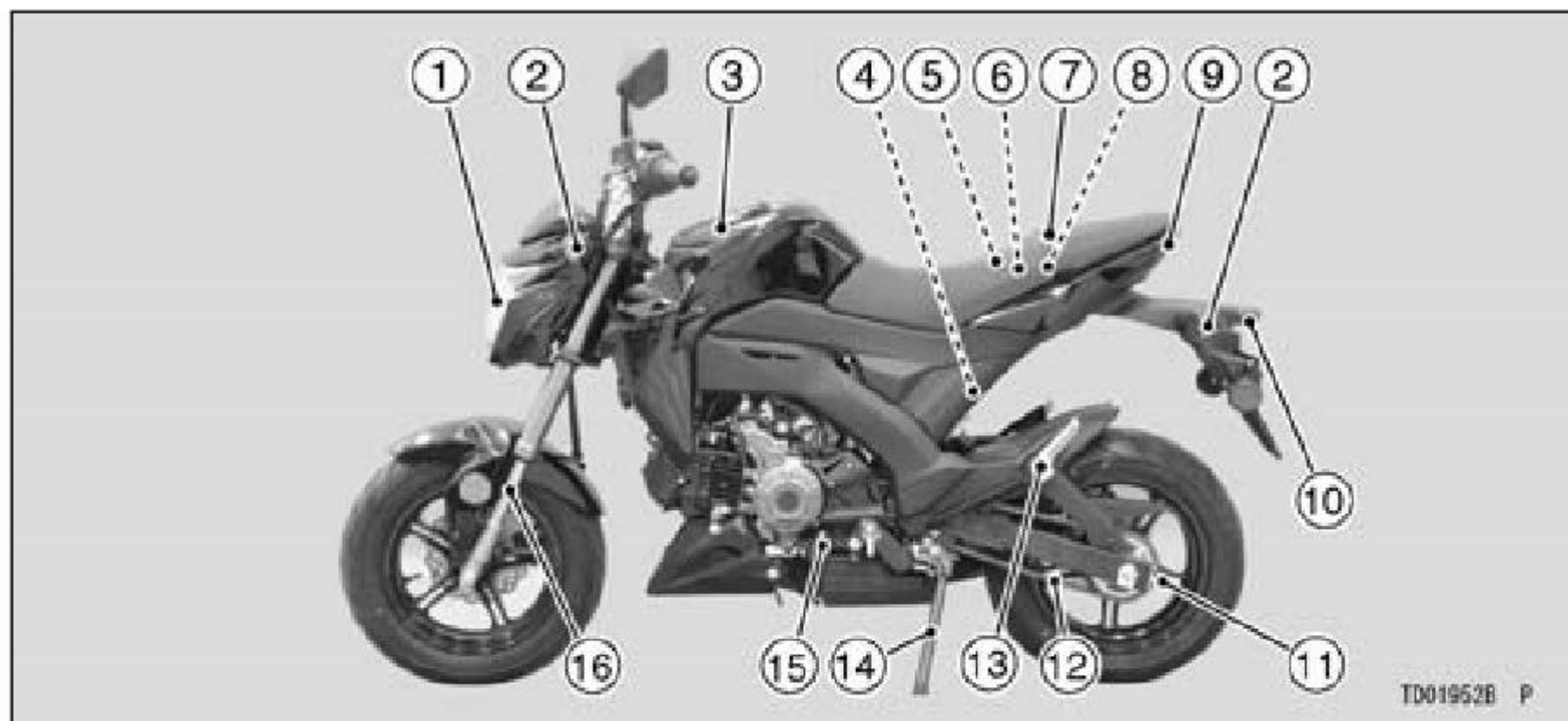

TD01952B P

1. Headlight
2. Turn Signal Lights
3. Fuel Tank
4. Seat Lock
5. Tool Kit
6. Battery
7. Seat Strap
8. Helmet Hook

9. Tail/Brake Light
10. License Plate Light
11. Chain Adjuster
12. Drive Chain
13. Rear Footpeg
14. Side Stand
15. Shift Pedal
16. Front Fork

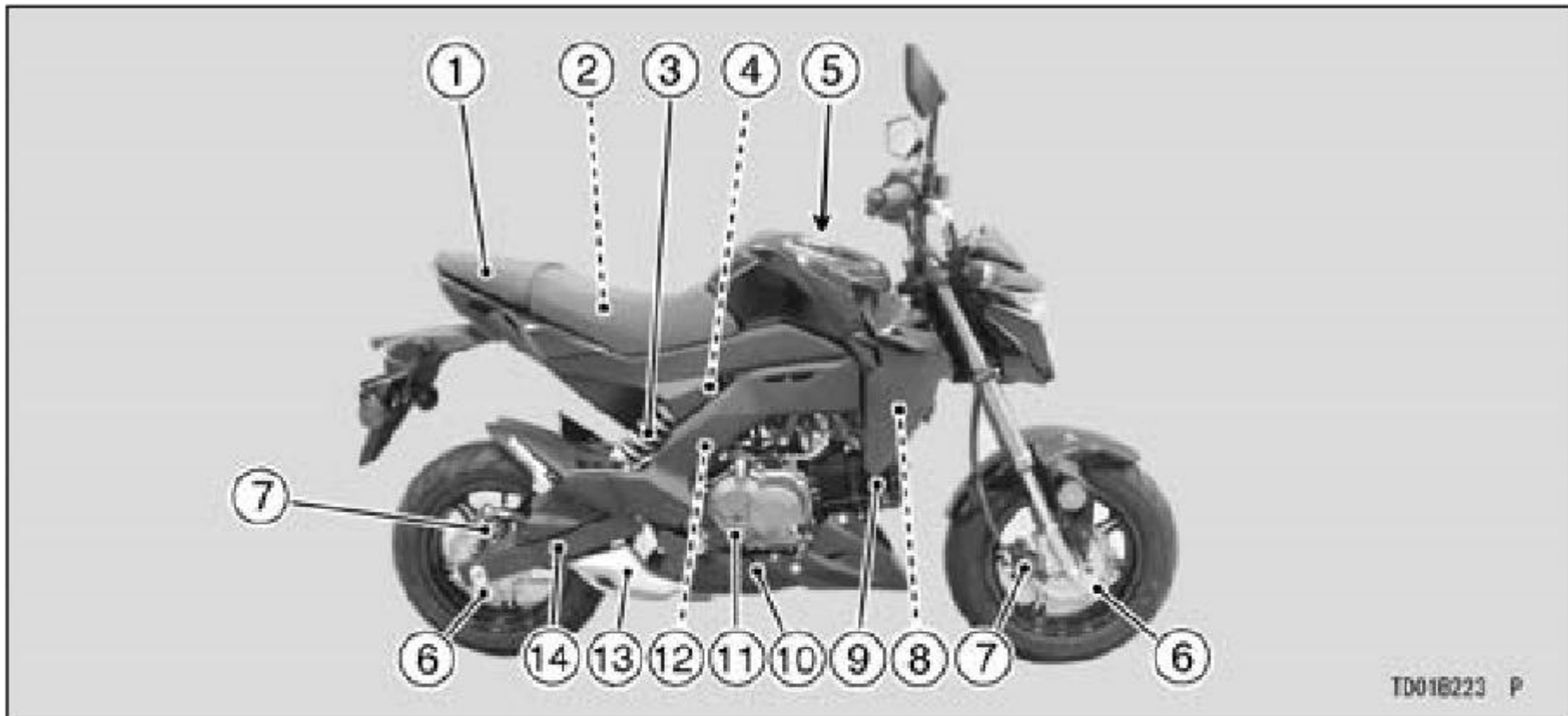

TD016223 P

- 1. Seat
- 2. Fuse Box
- 3. Rear Shock Absorber
- 4. Brake Fluid Reservoir (Rear)
- 5. Fuel Tank Cap
- 6. Brake Discs
- 7. Brake Calipers

- 8. Air Cleaner
- 9. Spark Plug
- 10. Rear Brake Pedal
- 11. Oil Filler Cap/Dipstick
- 12. Rear Brake Light Switch
- 13. Muffler
- 14. Swingarm

42 GENERAL INFORMATION

Meter Instruments

1. Lower Meter Button
2. Upper Meter Button
3. Tachometer
4. Multifunction Meter
5. Clock
6. Gear Position Indicator
7. Fuel Gauge
8. Speedometer
9. Multifunction Display
 - Odometer
 - Trip Meter A/B

When the ignition switch is turned on, all LCD functions are shown for a few seconds, then the multifunction meter turns to operational mode.

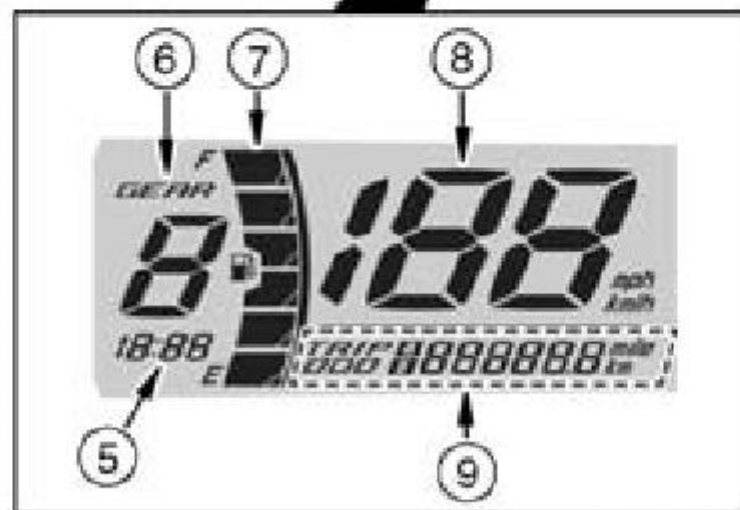

Indicators

1.  Fuel Level Warning Indicator
2.  Turn Signal Indicator (Green)
3.  High Beam Indicator (Blue)
4.  Neutral Indicator (Green)
5.  Engine Warning Indicator (Yellow)
6.  Battery Warning Indicator (Red)



T602702C 6

44 GENERAL INFORMATION

Indicator Initial Operation

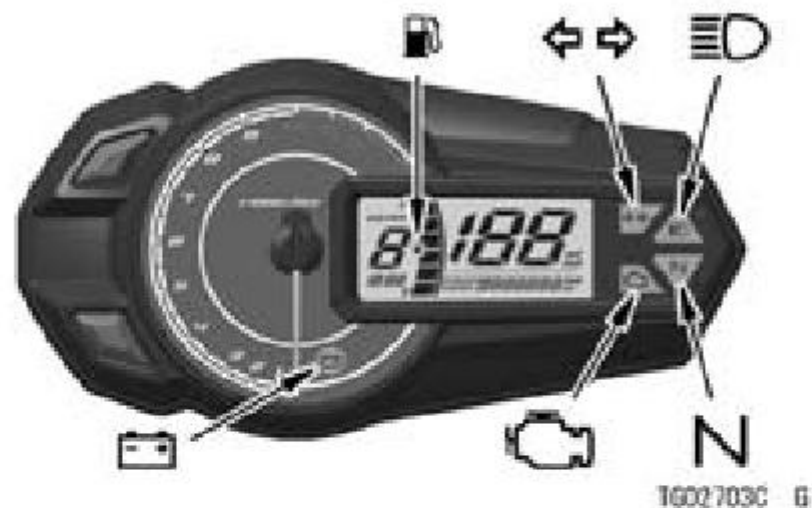

When the ignition switch is turned on, all indicators go on/off as shown in the table. If any indicator does not operate

as shown, have it checked by an authorized Kawasaki dealer.

ON			Indicators
<input type="checkbox"/>	<input type="checkbox"/>	<input type="checkbox"/>	N
<input type="checkbox"/>	<input type="checkbox"/>	<input checked="" type="checkbox"/>	
<input type="checkbox"/>	<input checked="" type="checkbox"/>	<input checked="" type="checkbox"/>	

ON: When ignition switch is turned on.

: After a few seconds

: When engine starts.



: Goes on.

: Goes off.

When Warning Indicators Go On or Blink

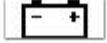

When warning indicators appear, there could be a problem with vehicle function. Follow actions in the table after stopping the vehicle in a safe place.

*: The numbers in this column corresponds to reference numbers on page 43.

*No.	Indicators	Status	Actions
1		Blink (with lowest segment)	The lowest segment and fuel level warning indicator blink in the multifunction meter when approximately 1.8 L (0.48 US gal) of usable fuel remains. Refuel at the earliest opportunity. If the vehicle is on the side stand, the warning indicator cannot estimate the amount of fuel in the tank. Stand the vehicle upright to check the fuel level.
		Blink (with all segments)	The fuel level warning system has malfunctioned. Contact an authorized Kawasaki dealer.
5		ON	The DFI system has malfunctioned. Contact an authorized Kawasaki dealer.
6		ON	This indicator goes on if the battery voltage is less than 11.0 V or more than 16.0 V. If the voltage is less than 11.0 V, charge the battery. If it does not solve the problem, contact an authorized Kawasaki dealer.

46 GENERAL INFORMATION

Other Indicators

*No.	Indicators	Status
2		When the turn signal switch is pushed to the left or right, this indicator blinks.
3		When the headlight is on high beam, this indicator goes on.
4		When the transmission is in neutral, this indicator goes on.

Speedometer/Tachometer

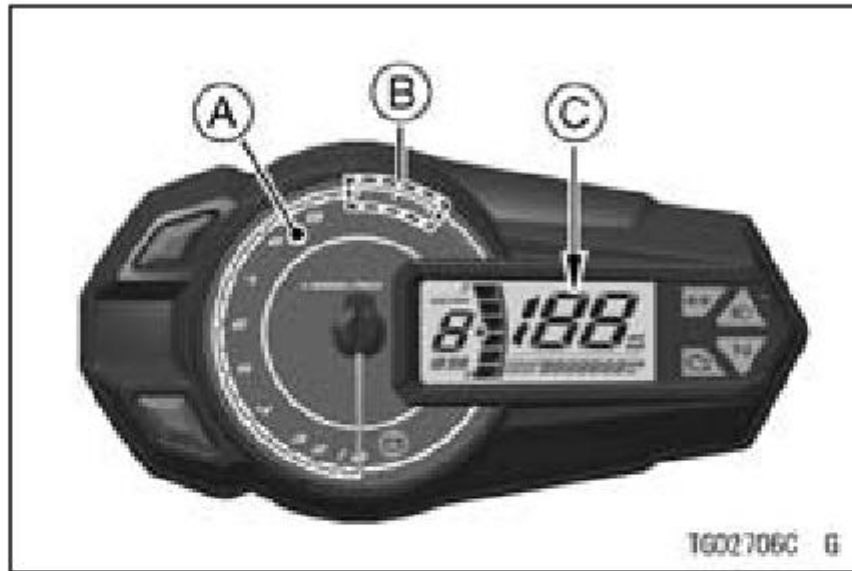

- A. Tachometer
- B. Red Zone
- C. Speedometer

Speedometer

The speedometer is digital and can be set for km/h or mph.

The unit setting can be changed according to local regulations. Make sure

the unit setting (km/h or mph) is correctly displayed before riding.

Refer to the Unit Setting in the Display Setting section.

Tachometer

The tachometer shows the engine speed in revolutions per minute (r/min, rpm).

NOTICE

Engine speed should not be allowed to enter the red zone; operation in the red zone will overstress the engine and may cause serious engine damage.

When the ignition switch is turned on, the tachometer needle momentarily sweeps from the minimum to the maximum reading, then back the minimum reading to check its operation. If

48 GENERAL INFORMATION

the tachometer does not operate correctly, have it checked by an authorized Kawasaki dealer.

Display Setting

Multifunction Display



WARNING

For Safety, do not operate the meter buttons while riding the motorcycle.

- Push the upper meter button to select the display modes. The display modes can be shifted in the following order.

NOTE

- *The multifunction display is displayed in the unit depending on the unit mode setting.*

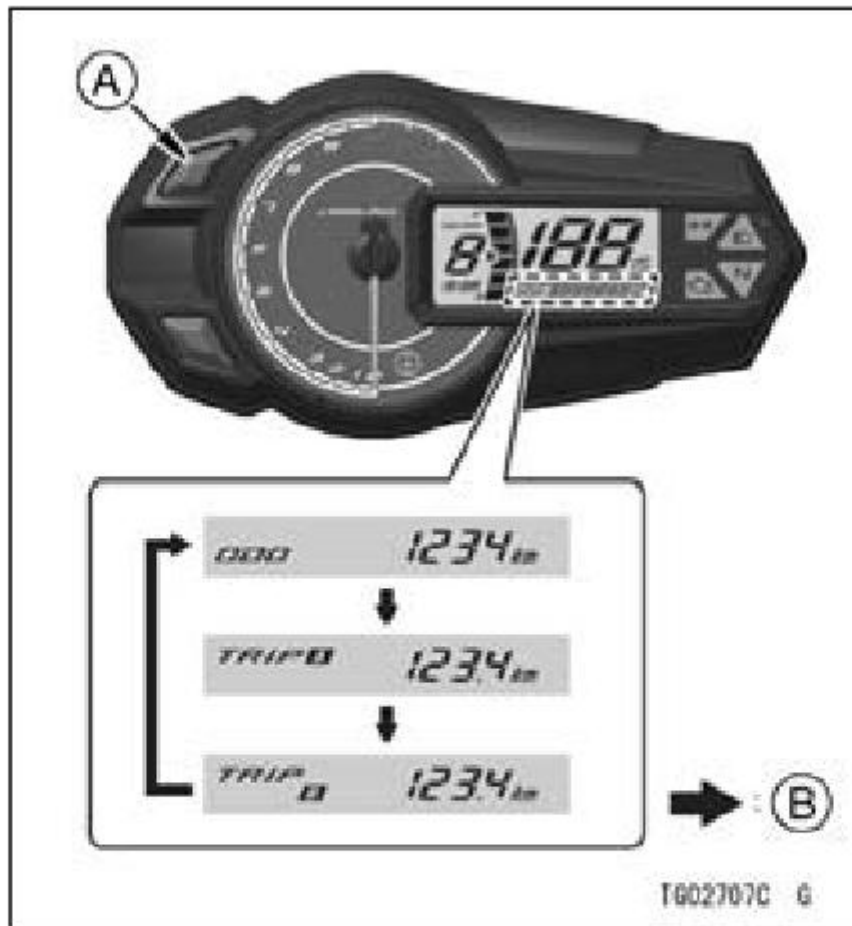

A. Upper Meter Button
 B. Flow when pushing upper meter button

Odometer

The odometer shows the total distance. This meter cannot be reset.

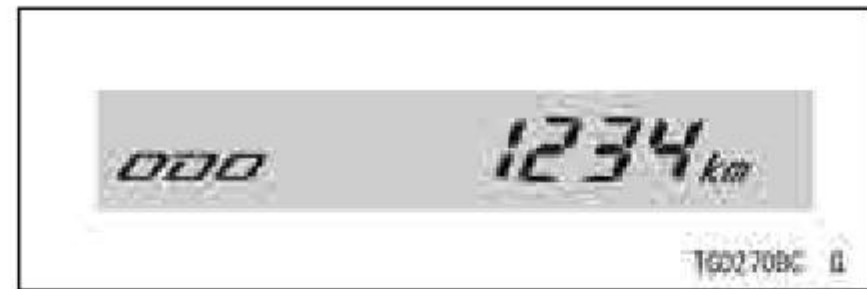

NOTE

○ When the figures come to 999999, the display is stopped and locked.

Trip Meter

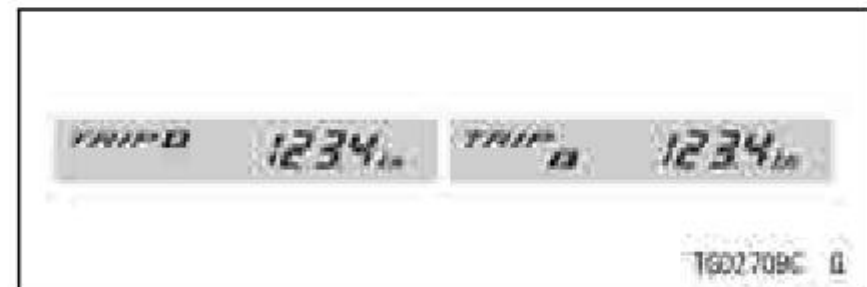

To reset the trip meter:

- Push the upper meter button to display the trip meter A/B.
- Push the lower meter button and hold it in until the display turns to 0.0.

50 GENERAL INFORMATION

NOTE

- *When the trip meter reaches 9999.9 while riding, the meter resets to 0.0 and continues counting.*

Clock

To adjust the clock:

- Push the upper meter button to display the odometer.
- Push the lower meter button and hold it until both the hour and minute displays blink.



- Push the lower meter button to select the hour or minute digits.

- Push the upper meter button to adjust the hour or minute digits.
- To finish the adjustment, push the upper meter button when both the hour and minute digits blink.

NOTE

- *When the battery is disconnected, the clock is reset to 1:00 and starts working again when the battery is connected.*

Unit Setting

The unit setting in the meter instrument can be changed according to local regulations. Make sure the unit setting is correctly displayed before riding.

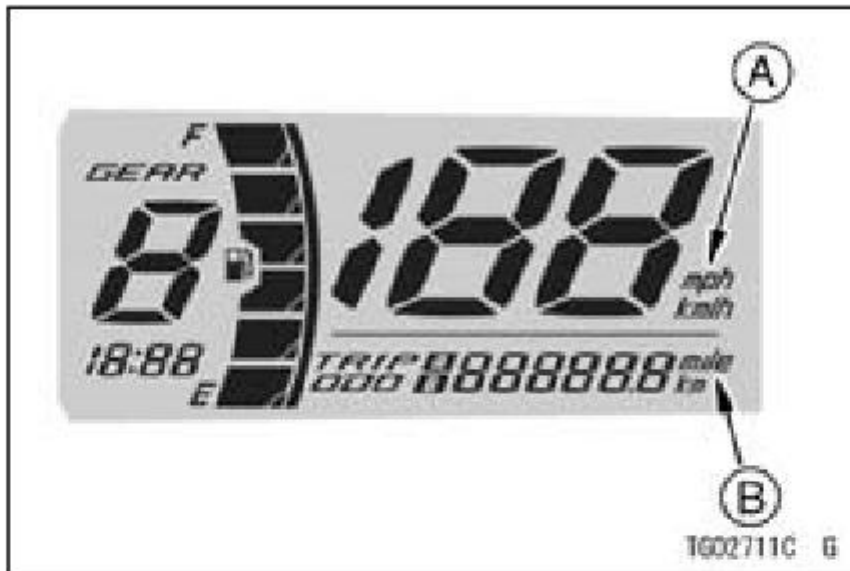

- A. mph or km/h Display
- B. mile or km Display

NOTE

○ Do not operate the motorcycle with wrong unit (mph or km/h) of the speedometer.

To change the unit:

- Push the upper meter button to display the odometer.

- Push the lower meter button while pushing the upper meter button to select the display unit.

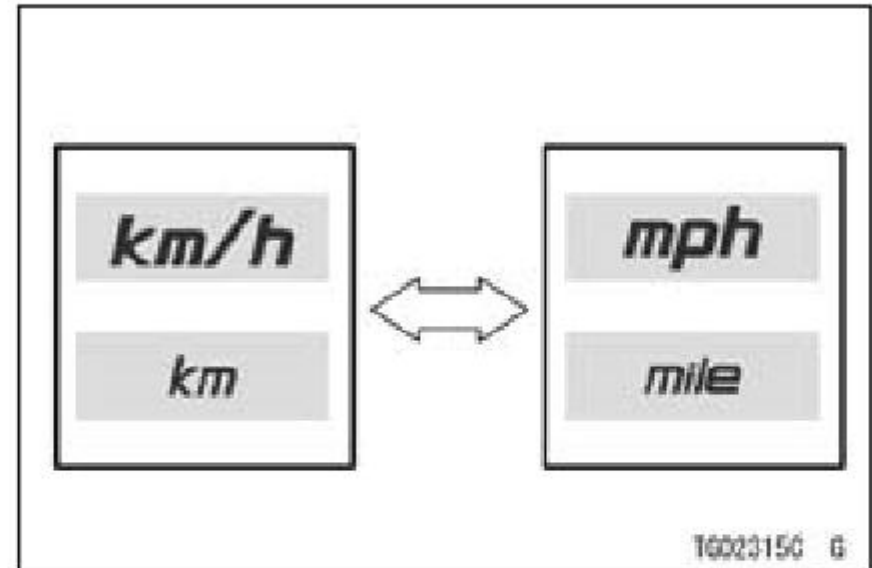

Features

Fuel Gauge

The fuel level in the fuel tank is shown by the number of segments displayed between E (empty) and F (full).

52 GENERAL INFORMATION

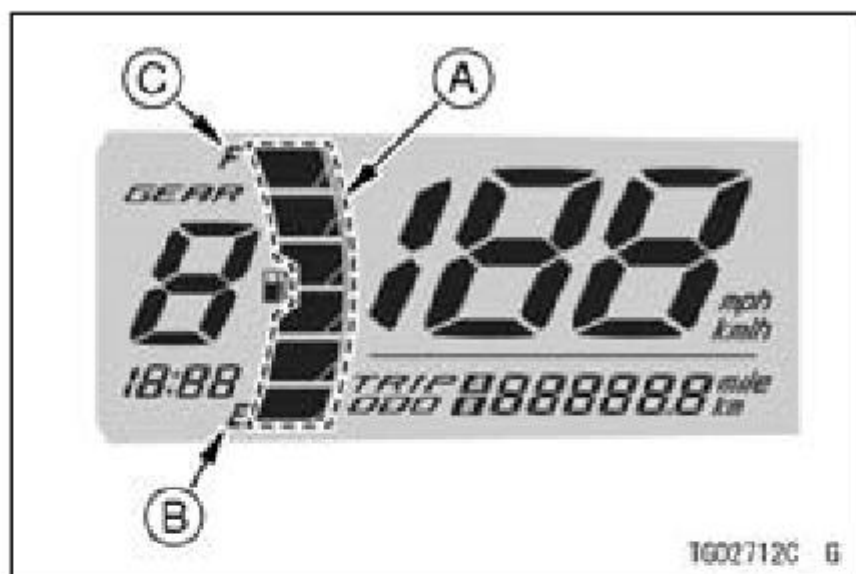

- A. Segments
- B. E (Empty)
- C. F (Full)

NOTE

- When the fuel tank is full, all the segments are displayed. As the fuel level in the tank goes down, the segments disappear one by one from F (full) to E (empty).
- When the fuel level warning indicator and segment(s) blink, refer to the

“When Warning Indicators Go On or Blink” in the Indicators section in this chapter.

Gear Position Indicator

This display shows the corresponding gear position when the transmission is shifted. As the transmission is shifted, the corresponding gear position (1st – 4th) is shown in this display. When the transmission is in neutral, the neutral indicator goes on.

1	When the transmission is in 1st gear, “1” is displayed.
2	When the transmission is in 2nd gear, “2” is displayed.
3	When the transmission is in 3rd gear, “3” is displayed.
4	When the transmission is in 4th gear, “4” is displayed.

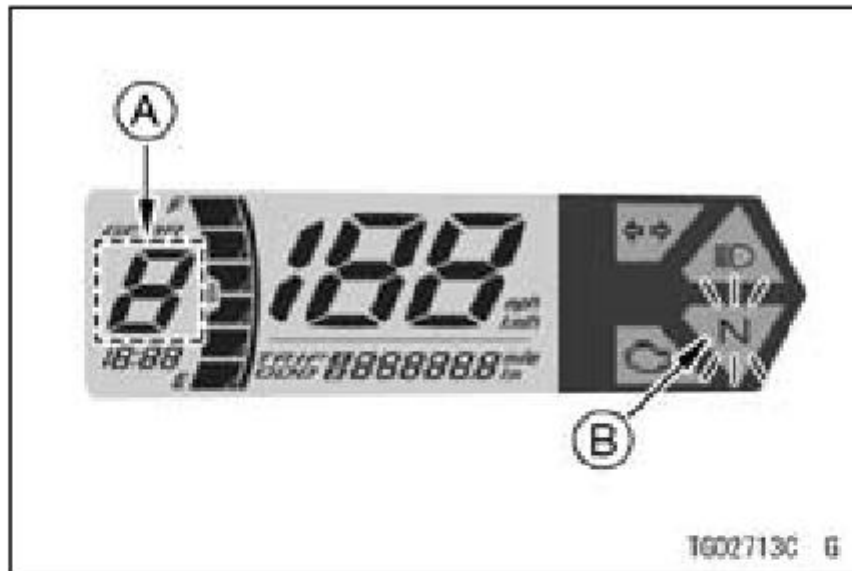

- A. Gear Position Indicator
- B. Neutral Indicator

NOTE

- If the gear position display in the multifunction meter shows “–,” the transmission is not properly shifted to 1st. Be sure to shift the transmission.

Keys

You will need the key number or spare key to have a duplicate made.

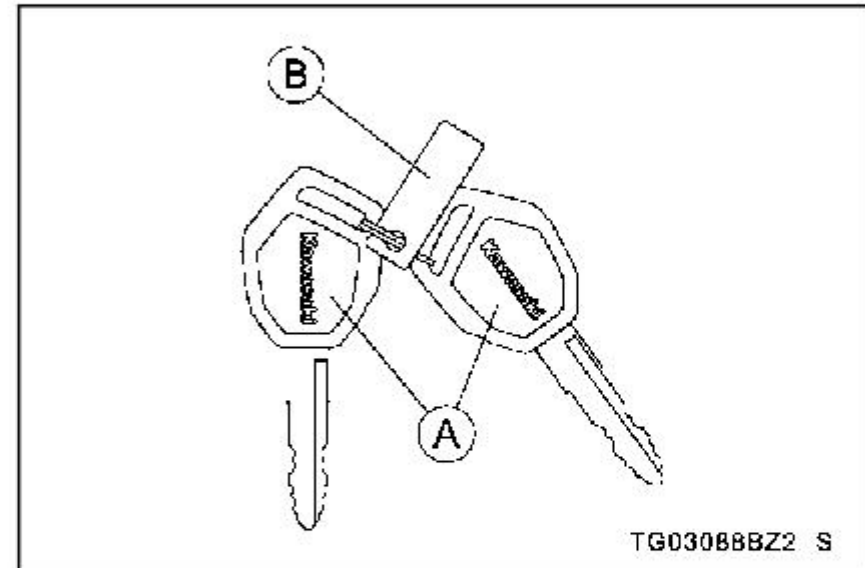

- A. Ignition Key
- B. Key Number Tag

If you lose all keys and the key number, you will need to replace the ignition switch and all other locks operated by that key.

Contact your Kawasaki dealer to purchase additional spare keys.

Ignition Switch/Steering Lock

This is a three-position, key-operated switch.

The key can be removed when it is in the “OFF” or “LOCK” position.

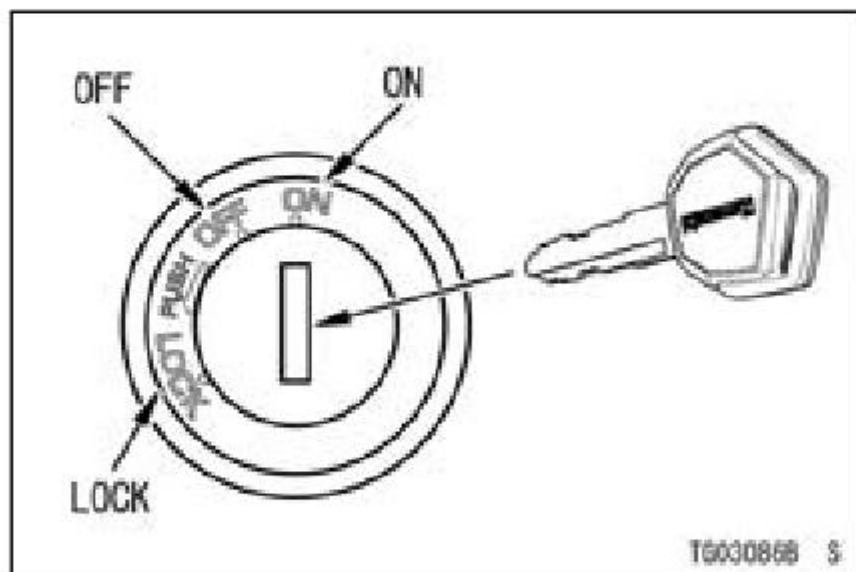

ON	<ul style="list-style-type: none"> ● Engine can be started. ● All electrical equipment can be used. ● Key cannot be removed.
OFF	<ul style="list-style-type: none"> ● Engine off. ● Electrical equipment is off. ● Key can be removed.
LOCK	<ul style="list-style-type: none"> ● Steering locked. ● Engine off. ● Electrical equipment is off. ● Key can be removed.

For locking:

1. Turn the handlebars fully to the left.
2. Push the key down in the “OFF” position and turn it to “LOCK.”



WARNING

Turning the ignition switch to the “OFF” position while riding the motorcycle shuts down the entire electrical system (headlight, brake light, turn signal light, etc) and the engine will stop, which could cause an accident resulting in severe injury or death. Never operate the ignition switch while riding the motorcycle; only operate it when the motorcycle is at a standstill.

NOTE

- *The tail, city and license plate lights are on whenever the ignition key is in the “ON” position. The headlight goes on when the starter button is released after starting the engine.*
- *Do not leave the ignition switch at the “ON” position for an extended time*

with the engine stopped, or the battery may become totally discharged.

Right Handlebar Switches

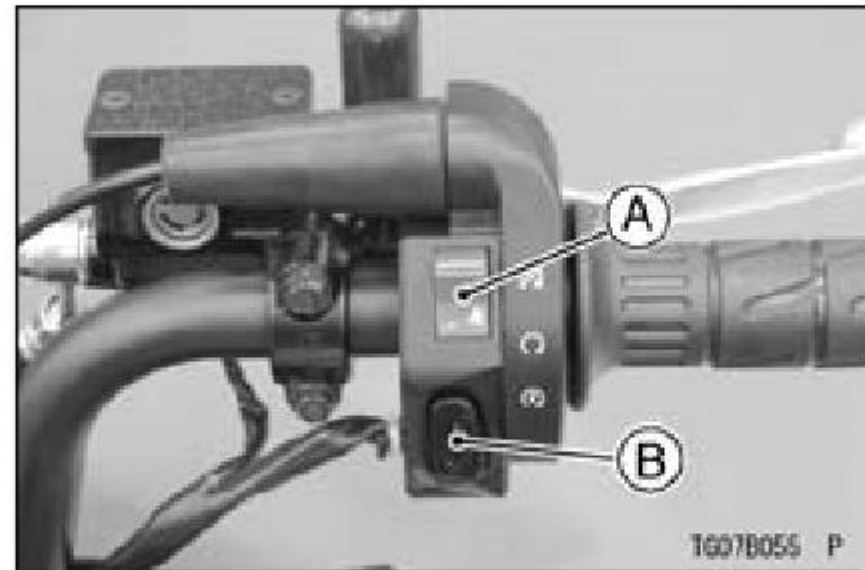

- A. Engine Stop Switch
- B. Starter Button

Starter Button

Refer to the Starting the Engine section in the HOW TO RIDE THE

56 GENERAL INFORMATION

MOTORCYCLE chapter for starting instructions.

Engine Stop Switch

To stop the engine in an emergency, move the engine stop switch to the  position.

Ordinarily, the engine stop switch must be in the  position for the motorcycle to operate.

NOTE

- Ordinarily, the ignition switch should be used to stop the engine.
- Although the engine stop switch stops the engine, it does not turn off all the electrical circuits and eventually the battery will be discharged.

Left Handlebar Switches

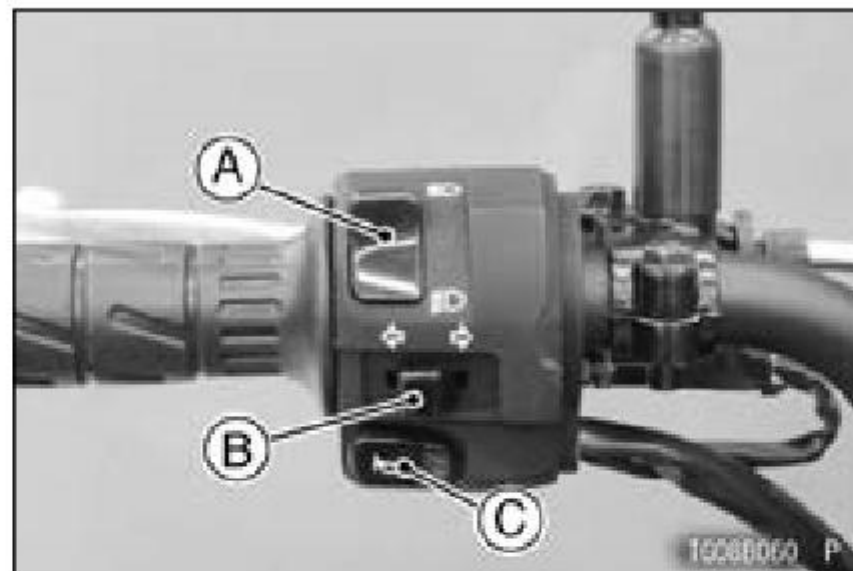

- A. Dimmer Switch
- B. Turn Signal Switch
- C. Horn Button

Dimmer Switch

High or low beam can be selected with the dimmer switch.



High beam...  (High beam indicator: see Meter Instruments section)

Low beam...  (Single light goes on)

NOTE

- *Do not allow anything to cover the headlight lens when the headlight is on. If covered, heat can build up in the headlight lens causing lens discoloration or melting, as well as damage to the item covering the lens.*

Turn Signal Switch

When the turn signal switch is turned to the left () or right (), the corresponding turn signal lights and turn signal indicator blinks. To cancel the turn signal, push the switch in.

Horn Button 

When the horn button is pushed, the horn sounds.

Fuel **WARNING**

Gasoline is extremely flammable and can be explosive under certain conditions, creating the potential for serious burns. Turn the ignition switch off.

Do not smoke.

Make sure the area is well ventilated and free from any source of flame or sparks; this includes any appliance with a pilot light.

Fuel Requirements

Use clean, fresh unleaded gasoline with the following conditions.

- Antiknock Index of 87 or more
- Up to 10% of ethanol contained

NOTICE

Use only unleaded gasoline. Never use leaded gasoline. Leaded gasoline significantly reduces the capability of the catalytic converter in the exhaust system.

NOTICE

Use minimum of 87 octane gasoline only to prevent severe engine damage.

NOTICE

If engine “knocking” or “pinging” occurs, use a different brand of gasoline of a higher octane rating. If this condition is allowed to continue it can lead to severe engine damage. Gasoline quality is important. Fuels of low quality or not meeting standard industry specifications may result in unsatisfactory performance. Operating problems that result from the use of poor quality or nonrecommended fuel may not be covered under your warranty.

NOTICE

Avoid using blends of unleaded gasoline and methanol (wood alcohol) whenever possible, and never use “gasohol” containing more than 5% methanol. Fuel system damage and performance problems may result.

NOTE

- *Other oxygenates approved for use in unleaded gasoline include TAME (up to 16.7%) and ETBE (up to 17.2%). Fuel containing these oxygenates can also be used in your Kawasaki.*

NOTICE

Never use gasoline with an octane rating lower than the minimum specified by Kawasaki. Never use “gasohol” with more than 10% ethanol, or more than 5% methanol.

Gasoline containing methanol must also be blended with cosolvents and corrosion inhibitors. Certain ingredients of gasoline may cause paint fading or damage. Be extra careful not to spill gasoline or gasoline oxygenate blends during refueling.

When not operating your Kawasaki for 30 to 60 days, mix a fuel stabilizer (such as STA-BIL) with the gasoline in the fuel tank. Fuel stabilizer additives inhibit oxidation of the fuel which minimizes gummy deposits.

60 GENERAL INFORMATION

Fuel Type and Octane Rating

Use clean, fresh unleaded gasoline.

The Antiknock Index is posted on service station pumps. The octane rating of a gasoline is a measure of its resistance to detonation or “knocking.” The Antiknock Index is an average of the Research Octane Number (RON) and the Motor Octane Number (MON) as shown in the table.

Fuel Type	Unleaded Gasoline
Ethanol Content	E10 or less
Antiknock Index	87 or more

NOTICE

Do not use any fuel that contains more ethanol or other oxygenates than specified for E10 fuel* in this vehicle. Damage to the engine and fuel system, or engine starting and/or performance problems may result from the use of improper fuel.

*E10 means fuel containing up to 10% ethanol.

Filling the Tank

Avoid filling the tank in the rain or where heavy dust is blowing so that the fuel does not get contaminated.

⚠ WARNING

Gasoline is extremely flammable and can be explosive under certain conditions, creating the potential for serious burns. Turn the ignition switch off. Do not smoke.

Make sure the area is well ventilated and free from any source of flame or sparks; this includes any appliance with a pilot light. Never fill the tank completely to the top.

If the tank is filled completely to the top, heat may cause the fuel to expand and overflow through the vents in the tank cap.

After refueling, make sure the tank cap is closed securely. If gasoline is spilled on the fuel tank, wipe it off immediately.

- Lift the key hole cover.
- Insert the ignition key into the fuel tank cap.
- Turn the key clockwise while pushing down the fuel tank cap.

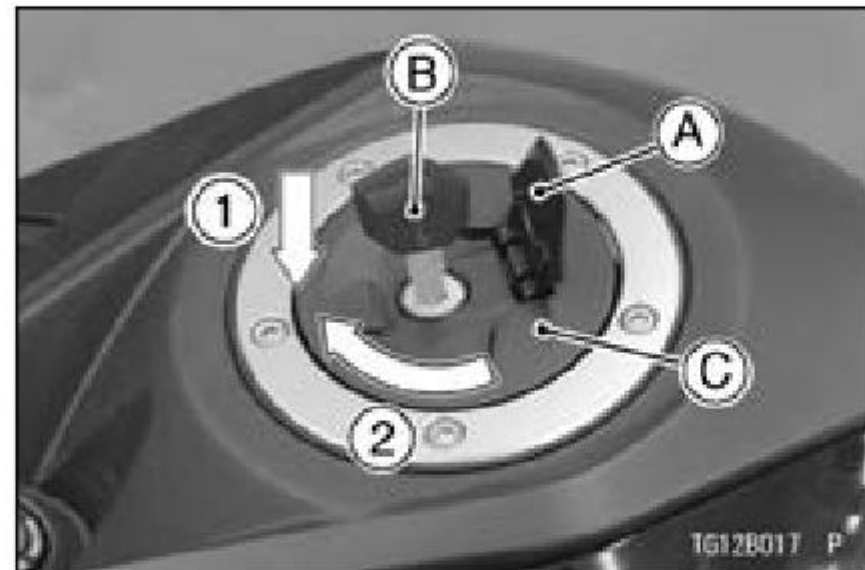

- A. Key Hole Cover
- B. Ignition Key
- C. Fuel Tank Cap

- Open the fuel tank cap.
- Add fuel.

62 GENERAL INFORMATION

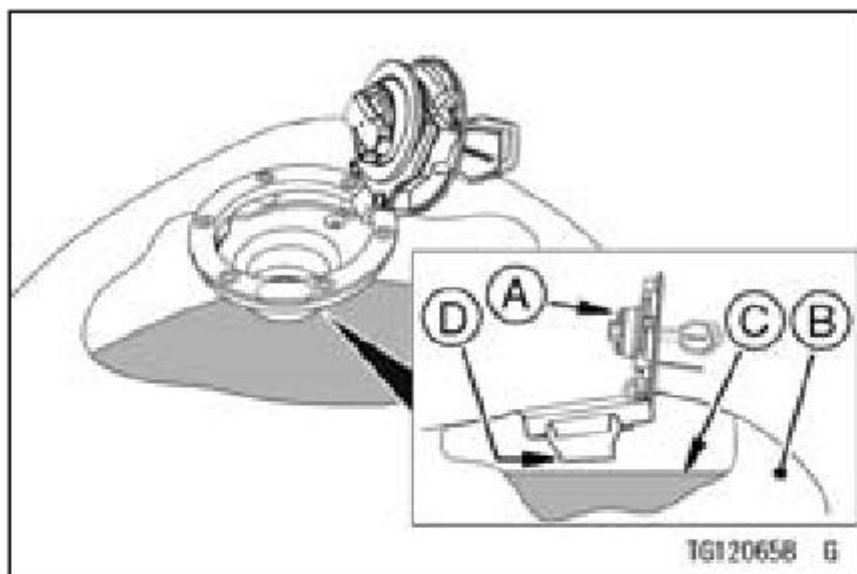

- A. Tank Cap
- B. Fuel Tank
- C. Top Level
- D. Bottom of Filler Neck (Maximum Fuel Level)

NOTE

- *Do not exceed the maximum fuel level as shown.*
- Push the fuel tank cap down into place with the key inserted.

- The key can be removed by turning counterclockwise to the original position.
- Close the key hole cover.

NOTICE

Never fill the tank completely to the top.

If the tank is filled completely to the top, heat may cause the fuel to expand and overflow through the vents in the tank cap.

After refueling, make sure the tank cap is closed securely.

If gasoline is spilled on the fuel tank, wipe it off immediately.

NOTE

- *The fuel tank cap cannot be closed without the key inserted, and the key*

cannot be removed unless the cap is locked properly.

- *Do not push on the key to close the cap, or the cap cannot be locked.*

Side Stand

Always kick the stand fully up before moving the motorcycle. The engine will stop automatically if the motorcycle is in gear and the clutch is released with the side stand down.

NOTE

- *When using the side stand, turn the handlebar to the left.*
- *Make sure the side stand is down securely before leaving the motorcycle.*

- *Do not sit on the motorcycle while it is on its side stand.*

Seat

The seat can be removed using the ignition key.

Seat Removal

- Insert the ignition key into the seat lock.
- Lift the rear of seat while turning the key clockwise.
- Remove the seat backward.
- Remove the ignition key.

64 GENERAL INFORMATION

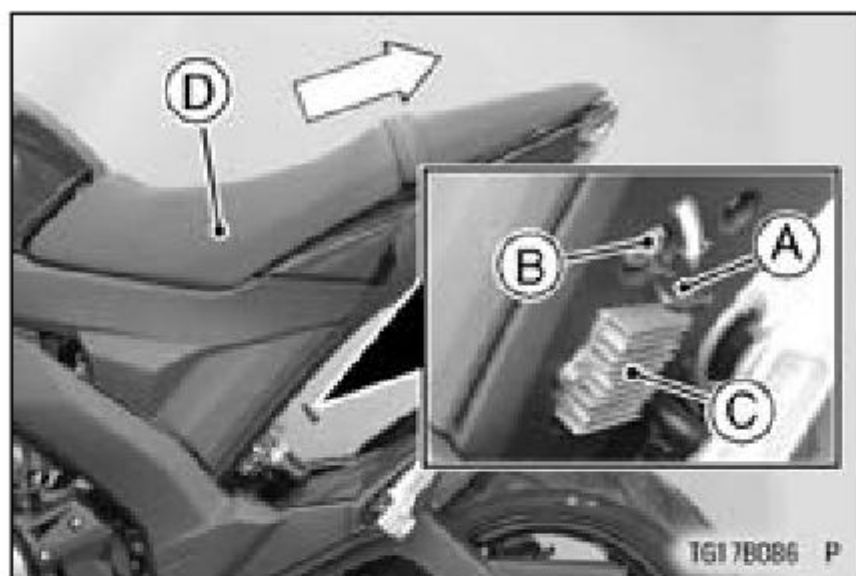

- A. Ignition Key
- B. Seat Lock
- C. Regulator/Rectifier
- D. Seat

NOTE

- *The regulator/rectifier could become hot while the engine is running or shortly after it has been stopped. Do not touch the regulator/rectifier in such situations.*

Seat Installation

- Insert the hook on the front of the seat to the bracket.

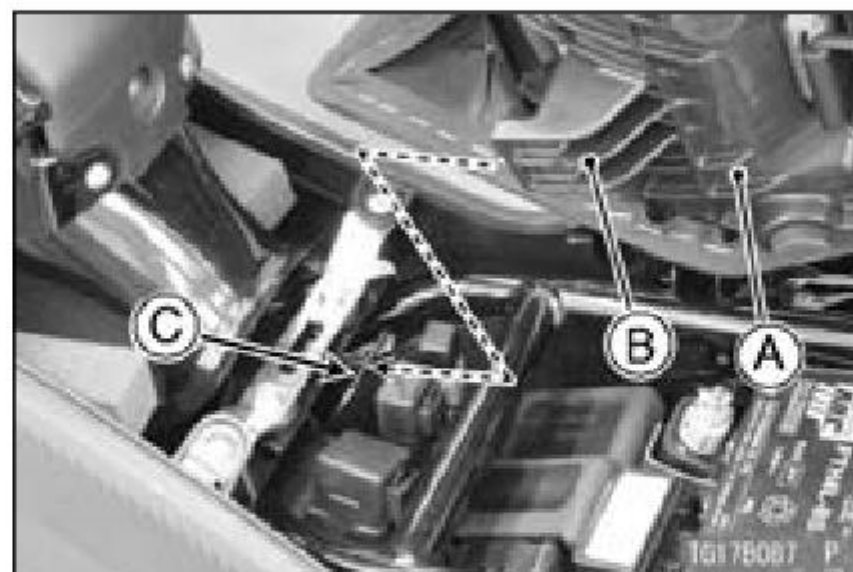

- A. Seat
- B. Hook
- C. Bracket

- Insert the projection on the rear of the seat into the hole of the seat lock.

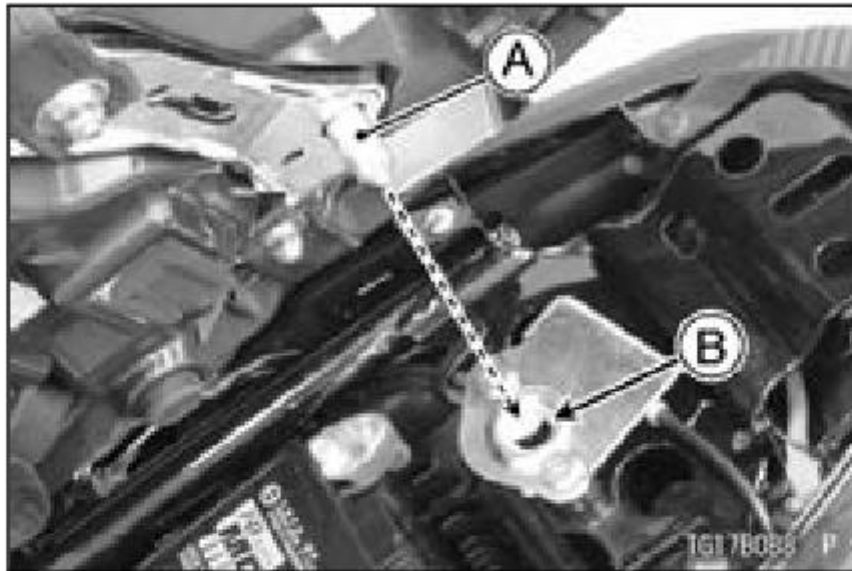

A. Projection

B. Hole

- Push down the rear part of the seat until the lock clicks.
- Pull up the front and rear ends of the seat to make sure they are securely locked.

Helmet Hook

Helmet can be secured to the motorcycle using the helmet hook. The helmet hook is located under the seat.

WARNING

Riding with a helmet attached to the hook could cause an accident by distracting the operator or interfering with normal vehicle operation. Do not ride the motorcycle with a helmet attached to the hook.

66 GENERAL INFORMATION



A. Helmet Hook

Tool Kit

The tool kit is located under the seat. Keep the tool kit in the original place.

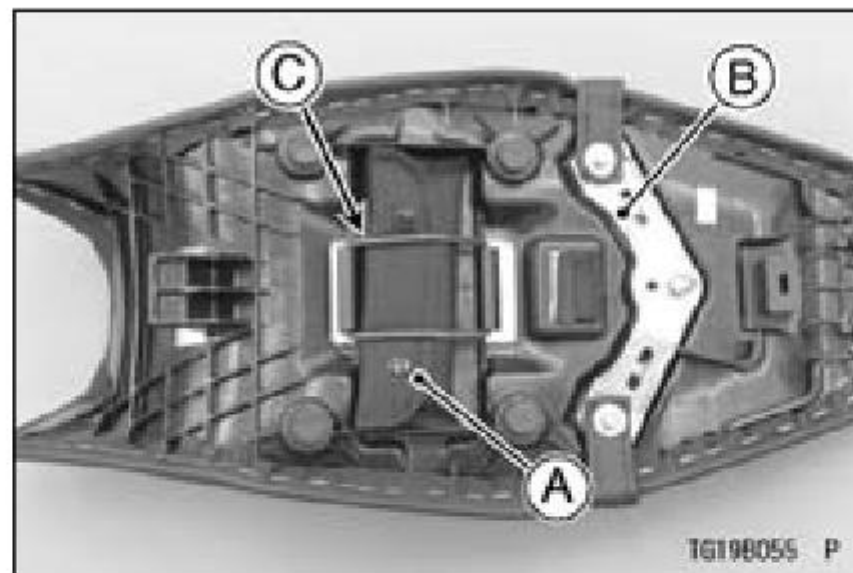

A. Tool Kit
B. Seat
C. Band

Rear View Mirror

Rear View Mirror Adjustment

- Adjust the rear view mirror by slightly moving only the mirror portion of the assembly.
- If the rear visibility can not be assured by moving the mirror, loosen

the upper hexagonal area and turn the stay by hand.

NOTE

- *The upper hexagonal area (locknut) has left hand threads.*

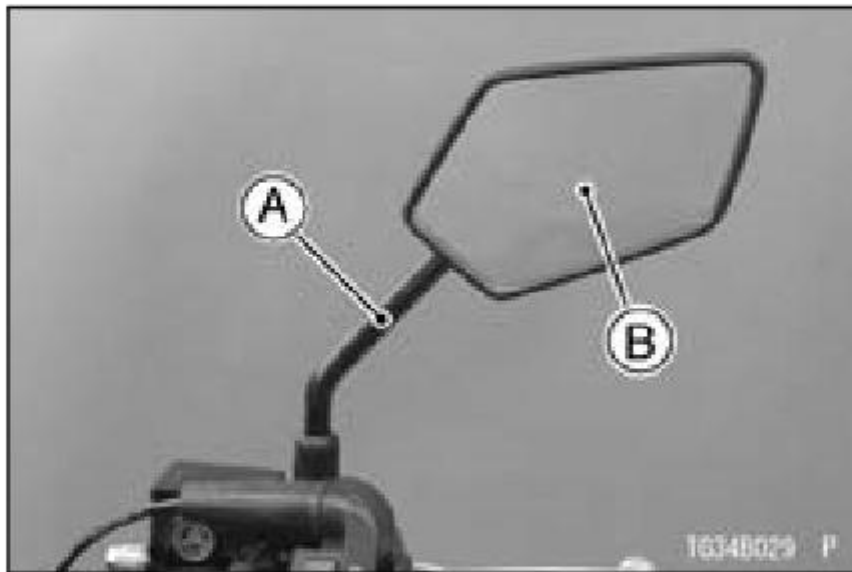

A. Stay
B. Rear View Mirror

Tightening Torque

Lower Hexagonal Area:

30 N·m (3.1 kgf·m, 22 ft·lb)

Upper Hexagonal Area:

18 N·m (1.8 kgf·m, 13 ft·lb)

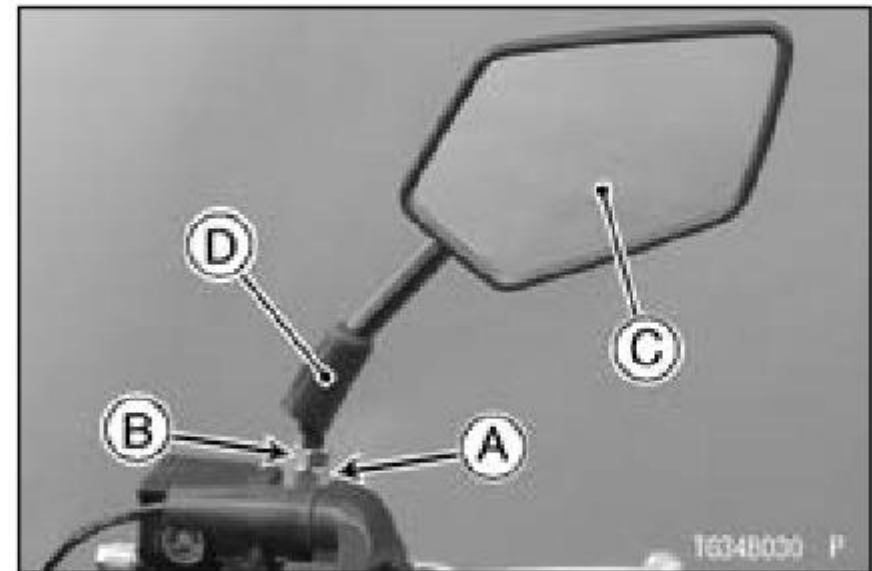

A. Lower Hexagonal Area for Tightening
B. Upper Hexagonal Area
C. Rear View Mirror
D. Rubber Boots

NOTE

- *If a torque wrench is not available, this item should be serviced by a Kawasaki dealer.*

Event Data Recorder

In common with many other vehicle manufacturers, Kawasaki has equipped this motorcycle with an event data recorder (EDR). The purpose of this device is to record data that assists with understanding of how some of the vehicle's systems were performing during a short period of time immediately before and during an accident or similar event involving minor damage. Due to accident variables, all vehicle performance data may not be stored on the EDR.

NOTE

- *During normal riding, data is recorded but not saved unless the vehicle is involved in an accident event.*
- *At no time other than in the event of an accident or similar event involving minor damage is it possible for EDR data to be stored for retrieval.*
- *Depending on the type of accident event, it is possible that the EDR may not record some or all of the data, or it may not record if the EDR is damaged.*
- *This device does not collect or store personal data or information (e.g. name, gender, age).*

The EDR in this vehicle is designed to record only data that is relevant to the vehicle's running condition at the time of an accident like, but not limited to,

vehicle speed, engine crankshaft rotational speed and throttle opening, etc.

This data can help provide a better understanding for both the rider and the manufacturer of how the vehicle was performing at the time of an accident or near accident-like situation.

To access information on an EDR, special equipment and access to the EDR is required. Kawasaki will not share EDR information without obtaining your consent, unless required by government authorities, or acting pursuant to lawful authority.



HOW TO RIDE THE MOTORCYCLE

Break-In

The first 1 000 km (600 miles) of use is the break-in period.

Follow the recommendations below to maintain the vehicle's performance and longevity.

Travelled distance	Maximum engine revolutions
0 – 200 km (0 – 150 miles)	4 000 r/min (rpm)
200 – 350 km (150 – 250 miles)	6 000 r/min (rpm)
350 – 1 000 km (250 – 600 miles)	Ride moderately

NOTE

- *You can ride above the maximum engine revolution stated in the break-in table briefly if necessary. Brief periods above the listed engine revolutions will not affect break-in results.*
- *When travelling on public roads, obey the speed limits.*
- *Do not race the engine while the transmission is in neutral.*

WARNING

New tires are slippery and may cause loss of control and injury. A break-in period of 160 km (100 miles) is necessary to establish normal tire traction. During break-in, avoid sudden and maximum braking and acceleration, and hard cornering.

In addition to the above, at 1 000 km (600 mile) it is extremely important that the owner has the initial maintenance service performed by an authorized Kawasaki dealer.

Starting the Engine

- Check that the engine stop switch is in the  position.

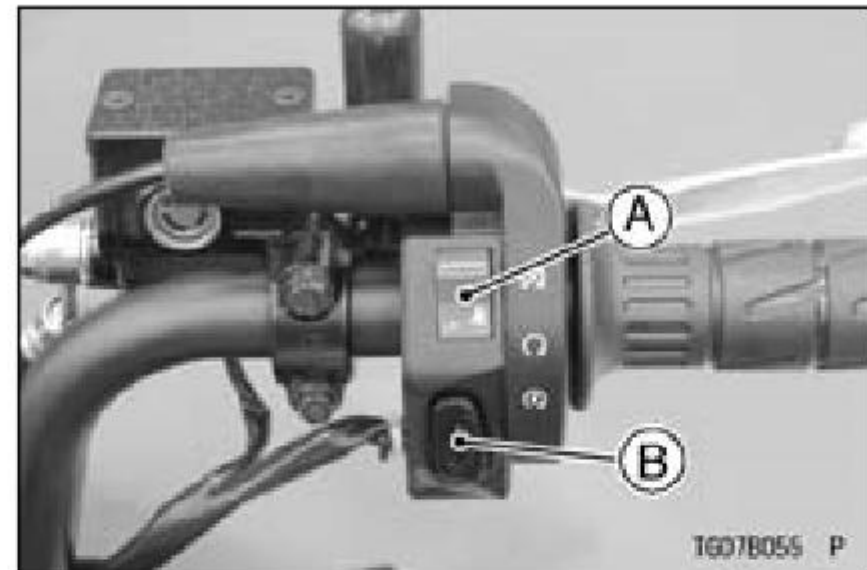

- A. Engine Stop Switch
- B. Starter Button

- Turn the ignition key to “ON” position.
- Make sure the transmission is in neutral.

72 HOW TO RIDE THE MOTORCYCLE

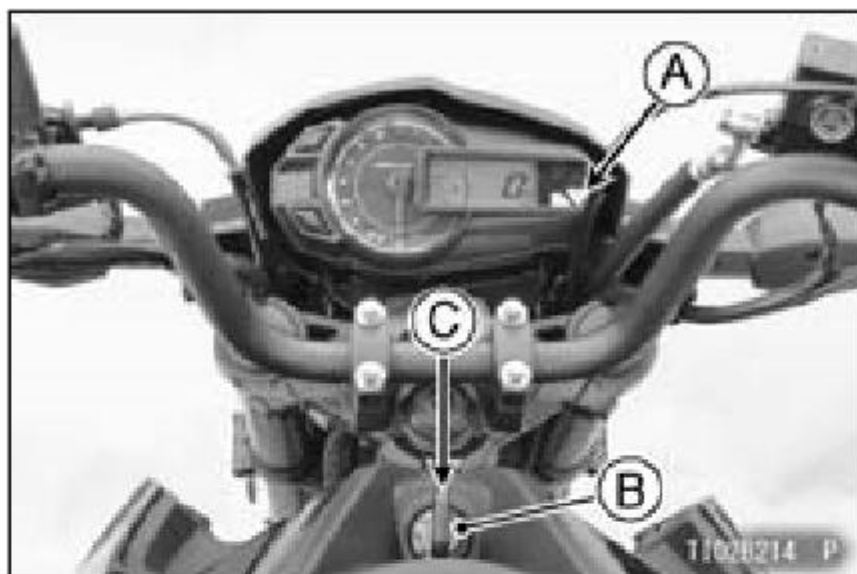

- A. Neutral Indicator (Green)
- B. Ignition Switch
- C. ON Position

NOTE

- *The motorcycle is equipped with a vehicle-down sensor which causes the engine to stop automatically if the motorcycle falls down. After righting the motorcycle, first turn the ignition key to “OFF” and then back to “ON” before starting the engine.*

- Without holding the throttle grip, push the starter button to start the engine after meter initial operation is finished.

NOTICE

Do not operate the starter continuously for more than 5 seconds, or the starter will overheat and the battery power will drop temporarily. Wait 15 seconds between each operation of the starter to let it cool and the battery power recover.

NOTE

- *The motorcycle is equipped with a starter lockout switch. This switch is designed so that the engine does not start if the transmission is in gear and the side stand is down. However, the*

engine can be started if the clutch lever is pulled and the side stand is fully up.

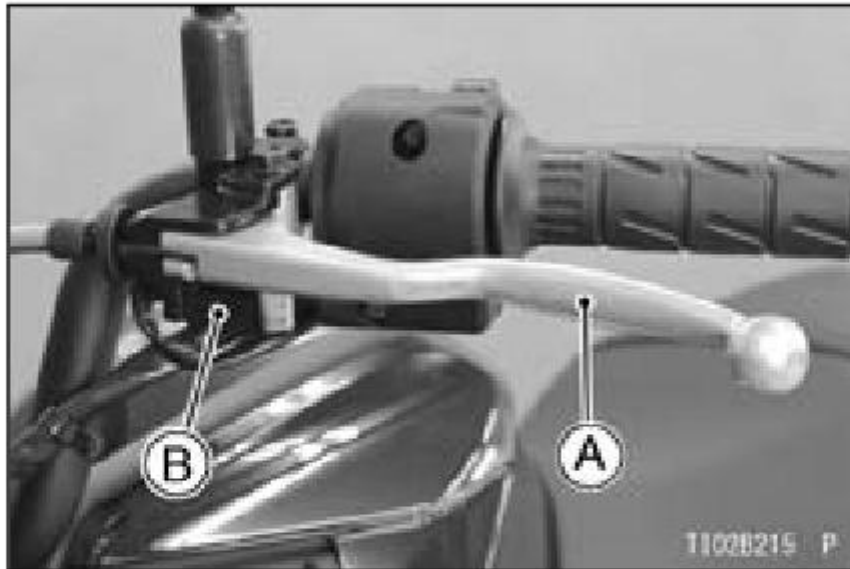

A. Clutch Lever
B. Starter Lockout Switch

NOTICE

Do not let the engine idle longer than 5 minutes, or engine overheating and damage may occur.

Moving Off

- Check that the side stand is up.
- Pull in the clutch lever.
- Shift into 1st gear.
- Open the throttle a little, and start to let out the clutch lever very slowly.
- As the clutch starts to engage, open the throttle a little more, giving the engine just enough fuel to keep it from stalling.

NOTE

- *The motorcycle is equipped with a side stand switch. This switch is designed so that the engine does not start if the transmission is in gear and the side stand is down.*

Shifting Gears

- Close the throttle while pulling in the clutch lever.

74 HOW TO RIDE THE MOTORCYCLE

- Shift into the next higher or lower gear.

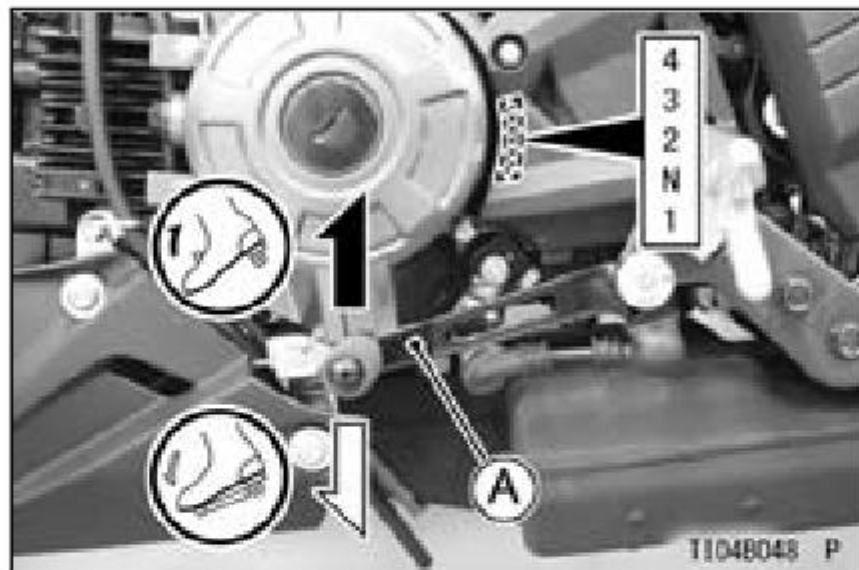

A. Shift Pedal

- Open the throttle part way, while releasing the clutch lever.
- For smooth riding, each gear position should cover the proper rate of speed shown in the table.

WARNING

Downshifting to a lower gear at high speed causes engine rpm to increase excessively, potentially damaging the engine and it may also cause the rear wheel to skid and cause an accident. Downshifting should be done below the vehicle speeds for each gear shown in the table.

Vehicle speed when shifting

Shifting up	km/h (mph)
1st → 2nd	15 (9)
2nd → 3rd	25 (15)
3rd → 4th	35 (21)

Shifting down	km/h (mph)
4th → 3rd	20 (12)
3rd → 2nd	15 (9)
2nd → 1st	15 (9)

NOTE

- *Excessive downshifting may adversely affect the operation of the electrical parts.*

Braking

- Close the throttle completely, leaving the clutch engaged (except when shifting gears) so that the engine will help slow down the motorcycle.
- Shift down one gear at a time so that you are in 1st gear when you come to a complete stop.
- When stopping, always apply both brakes at the same time. Normally the front brake should be applied a little more than the rear. Shift down or fully disengage the clutch as necessary to keep the engine from stalling.
- Never lock the brakes, or it will cause the tires to skid. When turning a corner, it is better not to brake at all. Reduce your speed before you get into the corner.
- For emergency braking, disregard downshifting, and concentrate on applying the brakes as hard as possible without skidding.

76 HOW TO RIDE THE MOTORCYCLE



A. Front Brake Lever

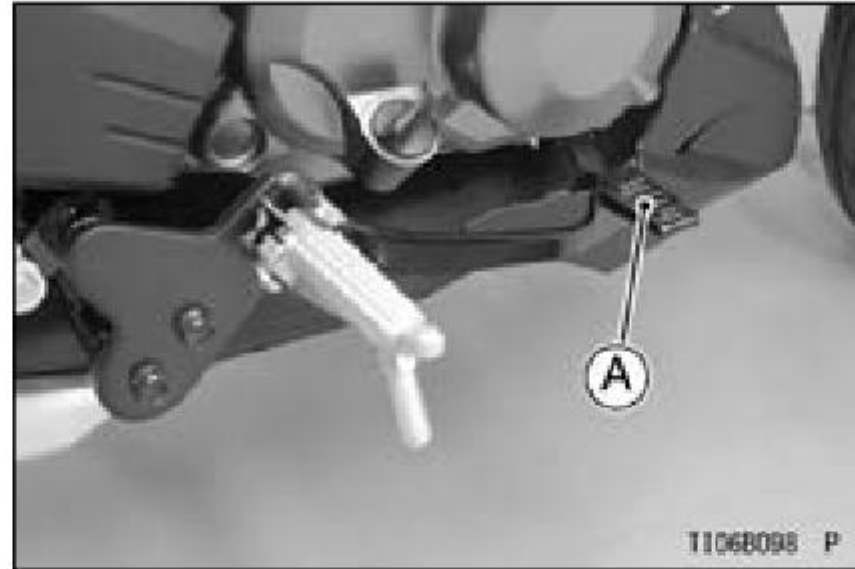

A. Rear Brake Pedal

Stopping the Engine

- Close the throttle completely.
- Shift the transmission into neutral.
- Turn the ignition key to "OFF."
- Support the motorcycle on a firm, level surface with the side stand.
- Lock the steering.

Stopping the Motorcycle in an Emergency

Your Kawasaki Motorcycle has been designed and manufactured to provide you optimum safety and convenience. However, in order to fully benefit from Kawasaki's safety engineering and craftsmanship, it is essential that you, the owner and operator, properly maintain your motorcycle and become thoroughly familiar with its operation. Improper maintenance can create a dangerous situation known as throttle failure. Two of the most common causes of throttle failure are:

1. An improperly serviced or clogged air cleaner may allow dirt and dust

to enter the throttle body and stick the throttle open.

2. During removal of the air cleaner, dirt is allowed to enter and jam the fuel injection system.

In an emergency situation such as throttle failure, your vehicle may be stopped by applying the brakes and disengaging the clutch. Once this stopping procedure is initiated, the engine stop switch may be used to stop the engine. If the engine stop switch is used, turn off the ignition switch after stopping the motorcycle.

Parking

WARNING

Operating or parking the vehicle near flammable materials can cause a fire, and can result in property damage or severe personal injury.

Do not idle or park your vehicle in an area where tall or dry vegetation, or other flammable materials could come into contact with the muffler or exhaust pipe.

WARNING

The engine and exhaust system get extremely hot during normal operation and can cause serious burns.

Never touch a hot engine, exhaust pipe, or muffler during operation or after stopping the engine.

- Shift the transmission into neutral and turn the ignition key to “OFF.”
- Support the motorcycle on a firm, level surface with the side stand.

NOTICE

Do not park on a soft or steeply inclined surface, or the motorcycle may fall over.

- If parking inside a garage or other structure, be sure it is well ventilated

and the motorcycle is not close to any source of flame or sparks; this includes any appliance with a pilot light.



WARNING

Gasoline is extremely flammable and can be explosive under certain conditions, creating the potential for serious burns. Turn the ignition switch off. Do not smoke. Make sure the area is well ventilated and free from any source of flame or sparks; this includes any appliance with a pilot light.

- Lock the steering to help prevent theft.



MAINTENANCE AND ADJUSTMENT

The maintenance and adjustments outlined in this chapter must be carried out in accordance with the Daily Checks and Periodic Maintenance to keep the motorcycle in good running condition and to reduce air pollution. **The initial maintenance is vitally important and must not be neglected.**



WARNING

Failure to perform these checks or to correct a problem before operation may result in serious damage or an accident. Always perform daily checks before operation.

Although items other than daily maintenance are described, this maintenance and repair work should be done by qualified technicians. Kawasaki does not recommend doing this work without knowledge and proper tools. Please note that Kawasaki cannot assume any responsibility for damage resulting from incorrect or improper adjustment made by the owner.

 **DANGER**

Exhaust gas contains carbon monoxide, a colorless, odorless poisonous gas. Inhaling carbon monoxide can cause serious brain injury or death. DO NOT run the engine in enclosed areas. Operate only in a well-ventilated area.

NOTE

- *If a torque wrench is not available, the maintenance items which require a specific torque value should be serviced by an authorized Kawasaki dealer.*

Daily Checks

Check the following items each day before you ride. The time required is minimal, and habitual performance of these checks will help ensure you a safe, reliable ride.

If any irregularities are found during these checks, contact an authorized Kawasaki dealer. Temporary measures methods are described on each page.

Operation	See Page
Fuel Adequate supply in tank, no leaks	—
Engine oil Oil level in the operating range (grid area) on the dipstick	89
Tires Air pressure (when cold), install the air valve cap Tire wear	114 115
Drive chain Slack: every 1 000 km (600 mile) Lubricate: every 600 km (400 mile)	104 103





Operation	See Page
<p>Bolts, nuts and fasteners Check for loose and/or missing bolts, nuts and fasteners</p>	—
<p>Steering Action smooth but not loose from lock to lock No binding of control cables</p>	— —
<p>Brakes Brake pad wear Brake fluid level No brake fluid leakage</p>	109 108 —
<p>Throttle Throttle grip free play</p>	99
<p>Clutch Clutch lever free play Clutch lever operates smoothly</p>	102 —

84 MAINTENANCE AND ADJUSTMENT

Operation	See Page
Electrical equipment All lights (head, city, brake/tail, turn signal, license plate, warning/indicator), meter and horn work	—
Engine stop switch Stops engine	—
Side stand Return to its fully up position by spring tension Return spring not weak or not damaged	— —
Rear view mirrors Rear view sight	—

Periodic Maintenance

- *A: Service at number of years shown or indicated odometer reading intervals, whichever comes first.
- *B: For higher odometer readings, repeat at the frequency interval established here.
- *C: Service more frequently when operating in severe conditions: dusty, wet, muddy, high speed, or frequent starting/stopping.
- *D: California model only
- : Emission Related Item













-  Q: Dealer Inspection
-  : Dealer Change or Replace
-  : Dealer Lubrication

86 MAINTENANCE AND ADJUSTMENT

Items	year (*A)	Odometer Reading (*B) × 1 000 km (× 1 000 mile)					See Page
		1 (0.6)	12 (7.6)	24 (15.2)	36 (22.8)	48 (30.4)	
○ Air cleaner element (*C)	↻:2		Q	Q	Q	Q	95
○ Idle speed		Q	Q	Q	Q	Q	101
○ Throttle control system (play, smooth return, no drag)	Q:1	Q	Q	Q	Q	Q	99
Fuel system	Q:1	Q	Q	Q	Q	Q	—
Fuel hose	↻:5						—
Evaporative emission control system (*D)				Q		Q	—
Valve clearance			Q	Q	Q	Q	—
Clutch operation (play, engagement, disengagement)	Q:1	Q	Q	Q	Q	Q	102
Engine oil (*C) and oil filter	↻:1	↻	↻	↻	↻	↻	90

Items	year (*A)	Odometer Reading (*B) × 1 000 km (× 1 000 mile)					See Page
		1 (0.6)	12 (7.6)	24 (15.2)	36 (22.8)	48 (30.4)	
Wheel bearing damage	Q:1		Q	Q	Q	Q	—
Drive chain wear (*C)		Q: every 6 000 km (3 800 mile)					—
Drive chain guide wear			Q	Q	Q	Q	—
Brake system	Q:1	Q	Q	Q	Q	Q	—
Brake operation (effectiveness, play, no drag)	Q:1	Q	Q	Q	Q	Q	—
Brake fluid (front and rear)	↻:2			↻		↻	—
Brake hose	↻:4						—
Rubber parts of brake master cylinder and caliper	↻:4					↻	—
Suspension system	Q:1		Q	Q	Q	Q	—
Lubrication of rear suspension				🔧		🔧	—

88 MAINTENANCE AND ADJUSTMENT

Items	year (*A)	Odometer Reading (*B) × 1 000 km (× 1 000 mile)					See Page
		1 (0.6)	12 (7.6)	24 (15.2)	36 (22.8)	48 (30.4)	
Steering play	Q:1	Q	Q	Q	Q	Q	—
Steering stem bearings	 :2						—
Electrical system	Q:1		Q	Q	Q	Q	—
Spark plug							93
Chassis parts	 :1						—
Condition of bolts, nuts and fasteners		Q	Q	Q	Q	Q	—

NOTE

○ *All owner daily maintenance items should also be checked at every scheduled dealer service.*

Engine Oil

Oil Level Inspection

- If the engine is cold, start the engine and run it for several minutes at idle speed.
- Stop the engine, then wait several minutes until the oil settles.

NOTICE

Racing the engine before the oil reaches every part can cause engine seizure.

- Clean the clutch cover around the oil filler cap/dipstick.

NOTICE

Be careful not to allow any dirt or foreign materials to enter the engine.

- With the motorcycle perpendicular to the ground, unscrew the oil filler cap/dipstick, wipe the dipstick on the cap dry, and reinsert it by screwing.

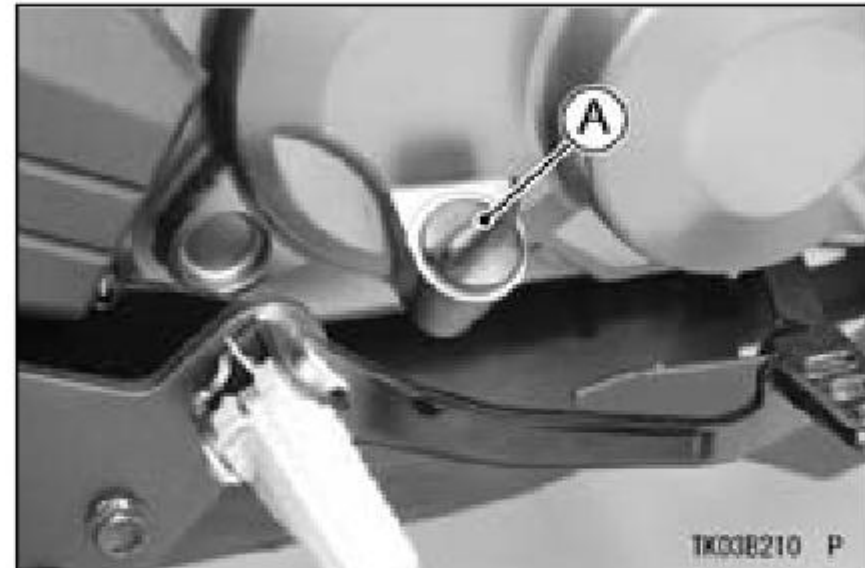

A. Oil Filler Cap/Dipstick

- Unscrew the oil filler cap/dipstick and check the engine oil level by the dipstick on the cap. The oil level should be between upper and lower level lines on the dipstick.

90 MAINTENANCE AND ADJUSTMENT

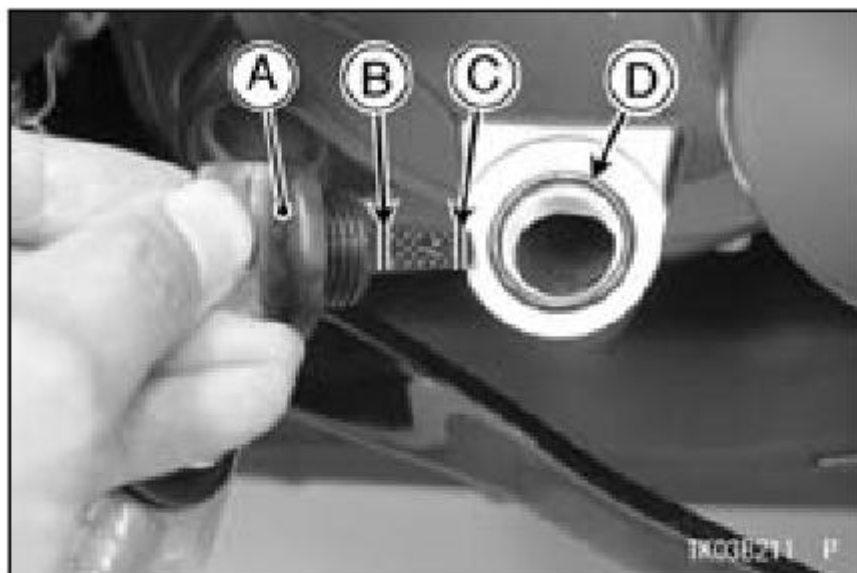

- A. Oil Filler Cap/Dipstick
- B. Upper Level Line
- C. Lower Level Line
- D. O-ring

- If the oil level is too high, remove the excess oil through the oil filler opening using a syringe or some other suitable device.
- If the oil level is too low, add oil to reach the correct level. Use the same type and brand of oil that is already in the engine.

NOTE

- Do not pinch the O-ring when installing the dipstick on the oil filler neck.
- When the O-ring comes off from the oil filler neck, install the O-ring on the oil filler neck correctly first, then install the dipstick.

Oil Change

- Warm up the engine thoroughly, and then stop it.
- Place an oil pan beneath the engine.
- Remove the engine oil drain bolt and gasket.

WARNING

Engine oil is a toxic substance. Dispose of used oil properly. Contact your local authorities for approved disposal methods or possible recycling.

MAINTENANCE AND ADJUSTMENT 91

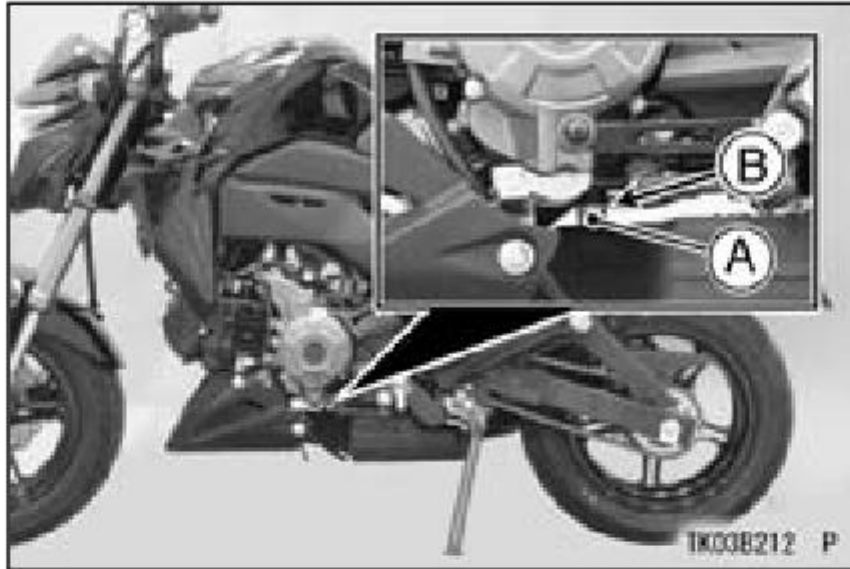

- A. Engine Oil Drain Bolt
- B. Gasket

- Let the oil completely drain with the motorcycle perpendicular to the ground.
- Replace the engine oil drain bolt gasket with a new one.

- Install the engine oil drain bolt with a new gasket. Tighten it to the specified torque.

Tightening Torque

Engine Oil Drain Bolt:

29 N·m (3.0 kgf·m, 21 ft·lb)

NOTE

- *If a torque wrench is not available, this item should be serviced by an authorized Kawasaki dealer.*
- Fill the engine up to the upper level line with a good quality engine oil specified in the table.

92 MAINTENANCE AND ADJUSTMENT

Recommended Engine Oil

Type:

Kawasaki Performance 4-Stroke
Motorcycle Oil*

Kawasaki Performance 4-Stroke
Semi-Synthetic Oil*

Kawasaki Performance 4-Stroke Full
Synthetic Oil*

or other 4-stroke oils with API SG, SH,
SJ, SL or SM with JASO MA, MA1 or
MA2 rating

Viscosity:

SAE 10W-40

*Kawasaki Performance Oils and Lubricants have been specifically engineered for your vehicle. Consistent use of these products meets or exceeds warranty and service requirements and can help to extend the life of your Kawasaki.

NOTE

○ *Do not add any chemical additive to the oil. Oils fulfilling the above requirements are fully formulated and provide adequate lubrication for both the engine and the clutch.*

Engine Oil Capacity

0.8 L (0.8 US qt)

[when filter is not removed]

0.9 L (1.0 US qt)

[when filter is removed]

Although 10W-40 engine oil is the recommended oil for most conditions, the oil viscosity may need to be changed to accommodate atmospheric conditions in your riding area.

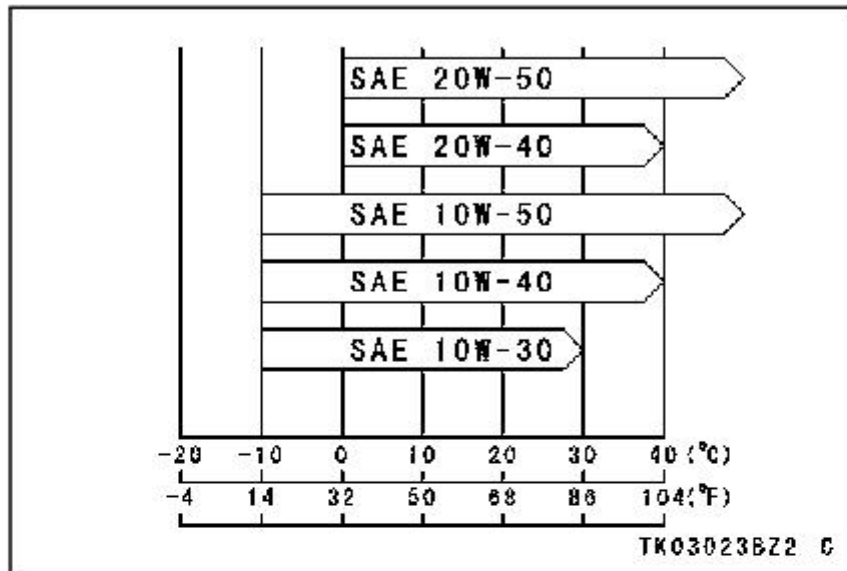

- Install the oil filler cap/dipstick.
- Start the engine.
- Check the oil level and oil leakage.

Oil Filter Change

Have the oil filter changed by an authorized Kawasaki dealer.

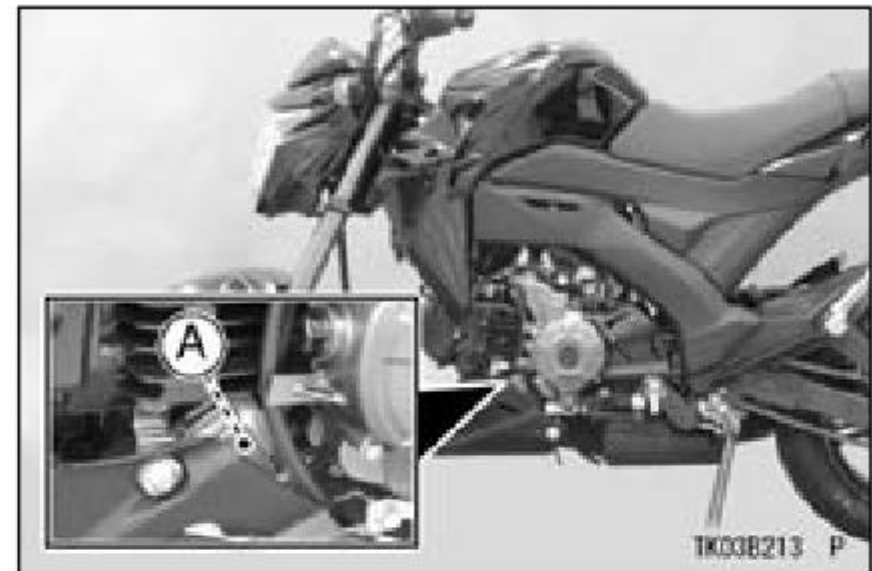

A. Oil Filter

Spark Plug

Spark Plug Replacement

- Carefully pull the spark plug cap from the spark plug.

NOTICE

When removing the spark plug cap, do not pull the lead. The lead could be broken off or damaged the wires inside.

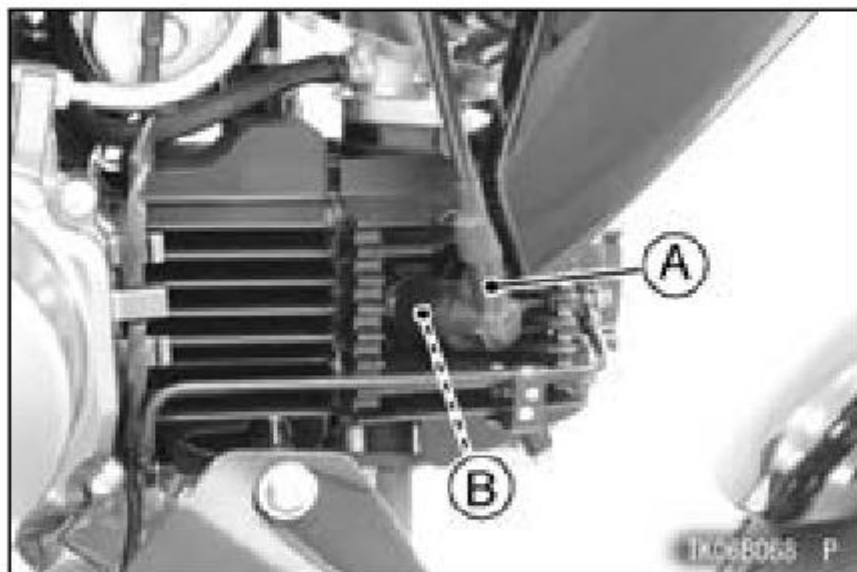

- A. Spark Plug Cap
- B. Spark Plug

- Unscrew the spark plug using the spark plug wrench included in the supplied tool kit.

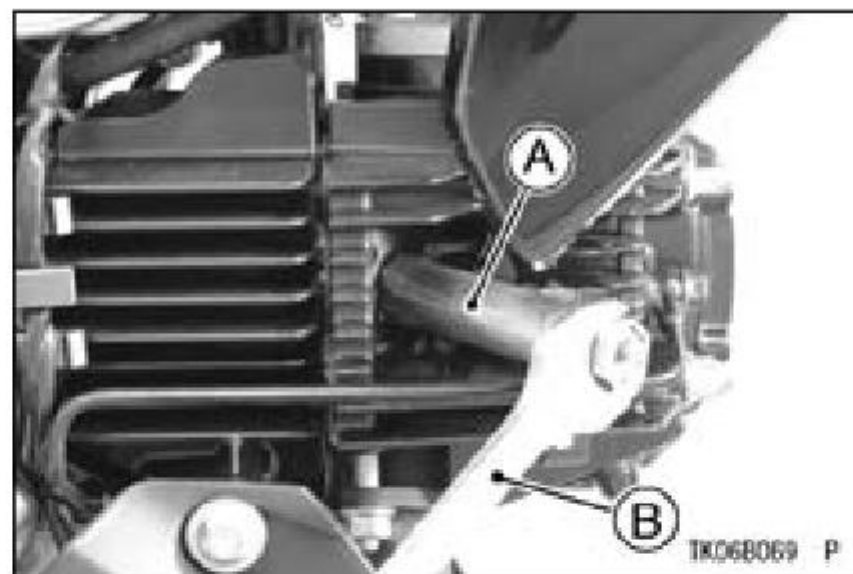

- A. Spark Plug Wrench
- B. Wrench

NOTE

- Spark plug installation is performed in the reverse order of removal.
- If a torque wrench is not available, this item should be serviced by an authorized Kawasaki dealer.
- Fit the plug cap securely onto the spark plug, and pull the cap lightly to make sure that it is properly installed.

○ Check the high-tension lead is not damaged, or correctly routed.

Spark Plug

Type	NGK CR6HSA
Plug Gap	0.6 – 0.7 mm (0.024 – 0.028 in.)
Tightening Torque	13 N·m (1.3 kgf·m, 115 in·lb)

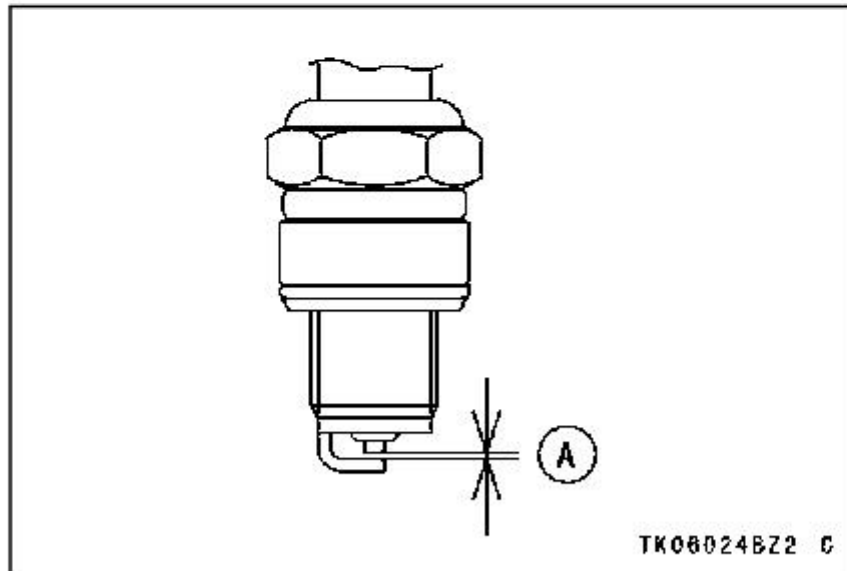

A. 0.6 – 0.7 mm (0.024 – 0.028 in.)

Air Cleaner

Air Cleaner Element Removal

- Disconnect the horn lead connectors.

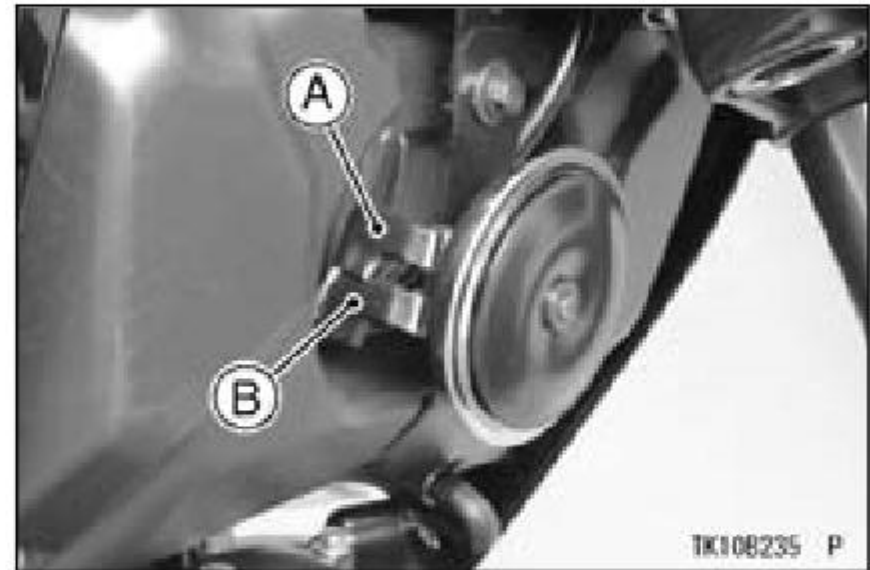

- A. Horn Lead Connector (Brown/White Lead)**
- B. Horn Lead Connector (Black Lead)**

- Slide the clamp and disconnect the hose.
- Remove the air cleaner cover screws and air cleaner cover.

96 MAINTENANCE AND ADJUSTMENT

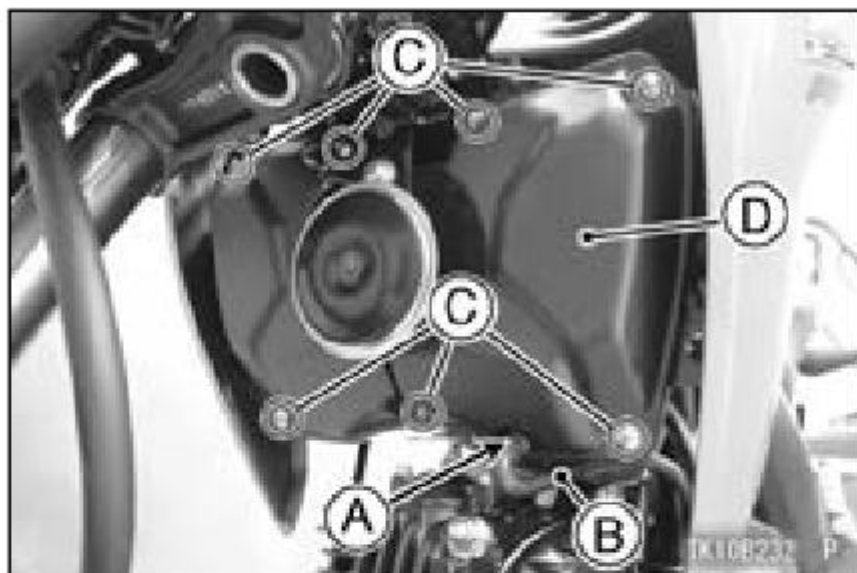

A. Clamp

B. Hose

C. Air Cleaner Cover Screws

D. Air Cleaner Cover

- Remove the air cleaner element and wire screen.

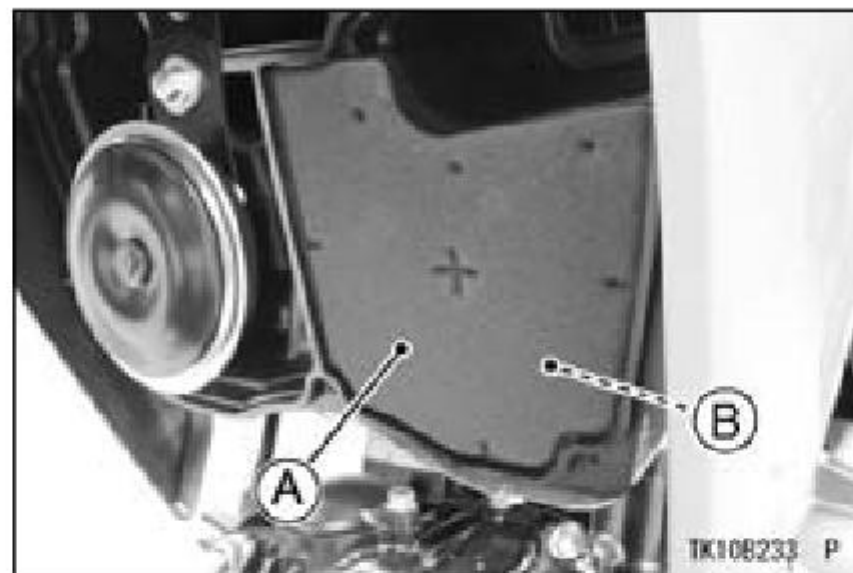

A. Air Cleaner Element

B. Wire Screen

- Put a clean, lint-free towel into the air cleaner housing to keep dirt or other foreign material from entering.
- Inspect the element material for damage. If any part of the element is damaged, the element must be replaced.

 **WARNING**

If dirt or dust is allowed to pass through into the throttle body assembly, the throttle may become stuck, possibly causing accident. Be sure to keep the dust from entering during cleaning.

NOTICE

If dirt gets through into the engine, excessive engine wear and possibly engine damage will occur.

Air Cleaner Element Cleaning

- Clean the element in a bath of a high flash-point solvent.
- Squeeze it dry in a clean towel. Do not wring the element or blow it dry; the element can be damaged.

- Check the element for visible damage.
- If element is damaged, replace it.
- After cleaning, saturate the element with a high-quality foam-air-filter oil, squeeze out the excess oil, then wrap it in a clean towel and squeeze it as dry as possible.
- Be careful not to tear the element.

 **WARNING**

Gasoline and low flash-point solvents are extremely flammable and may explode, causing severe burns. Do not use gasoline or a low flash-point solvent to clean the element. Clean the element in a well-ventilated area. Be sure there are no sparks or flame in the work area, including any appliance with a pilot light.

98 MAINTENANCE AND ADJUSTMENT

Air Cleaner Element Installation

- Before installation, check the element for damage such as tears, hardening, or shrinkage. If damaged, replace the element.
- Remove the towel from the air cleaner housing.
- Apply grease to the lateral side of the element (grid area) as shown.
- Install the wire screen and air cleaner element.

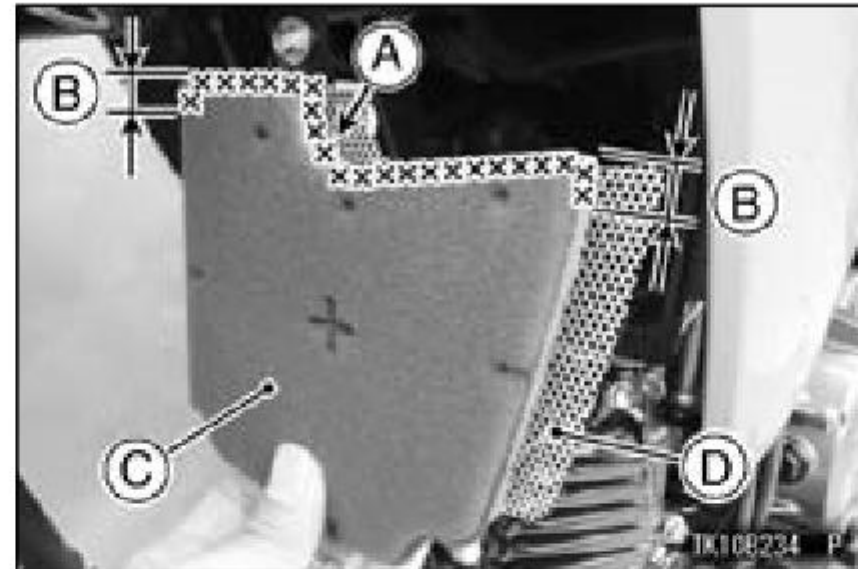

A. Lateral Side of the Element (Grid Area)

B. 10 mm (0.39 in.) from the end.

C. Element

D. Wire Screen

- Install the air cleaner cover.
- Tighten the air cleaner cover screws to the specified torque.

Tightening Torque

Air Cleaner Cover Screws: 1.2 N·m (0.12 kgf·m, 11 in·lb)

- Connect the hose and slide the clamp to the original position.

NOTE

- *When connecting the hose, avoid sharp bending.*

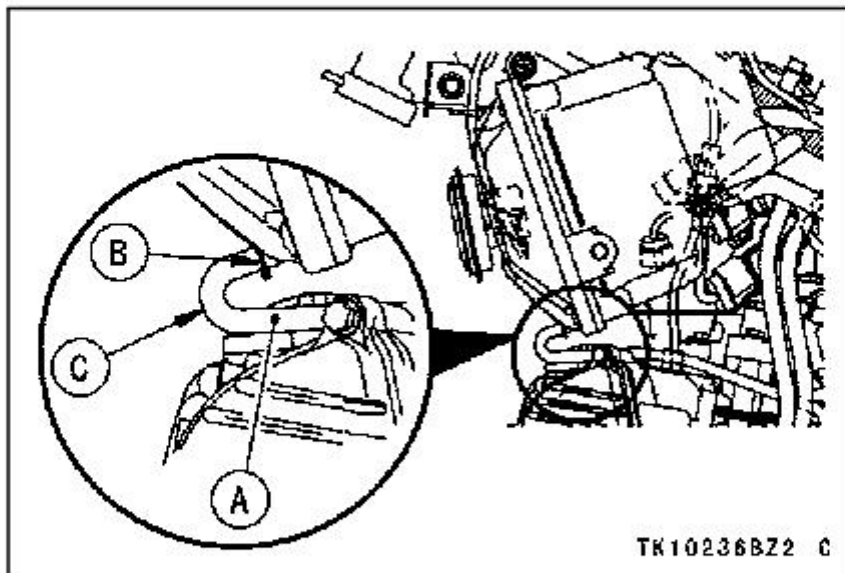

- A. Hose
- B. Clamp
- C. Do not bend sharply.

- Connect the horn lead connectors to the original position.

- Check the horn sounds normal.

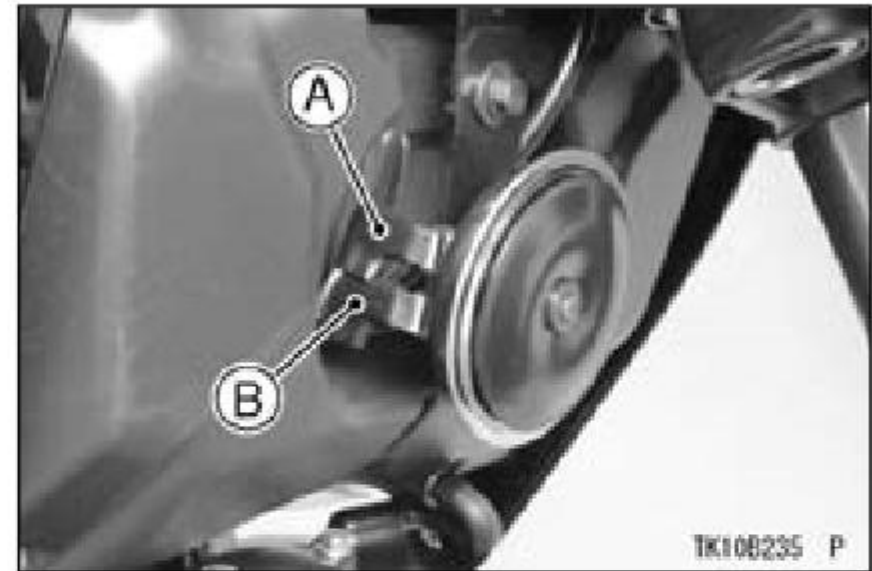

- A. Horn Lead Connector (Brown/White Lead)
- B. Horn Lead Connector (Black Lead)

Throttle Control System

Throttle Grip

Throttle Grip Free Play Inspection

- Check that the throttle grip moves smoothly from full open to close, and the throttle closes quickly and

100 MAINTENANCE AND ADJUSTMENT

completely by the return spring in all steering positions.

- If the throttle grip does not return properly, have the throttle control system checked by an authorized Kawasaki dealer.
- Check the throttle grip free play by turning back and forth.

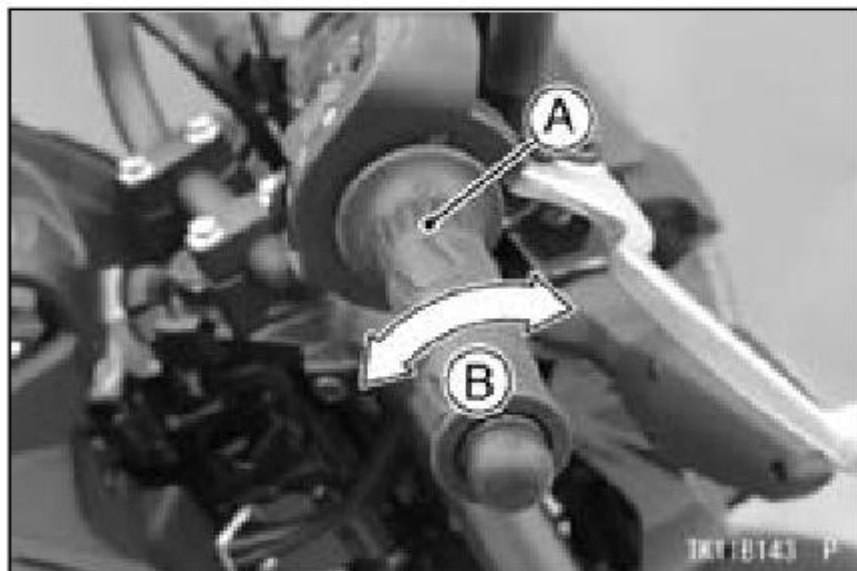

A. Throttle Grip
B. Throttle Grip Free Play

Throttle Grip Free Play

2 – 3 mm (0.08 – 0.12 in.)

- If there is improper play, adjust it.

Throttle Grip Free Play Adjustment

- Slide the dust cover.
- Loosen the locknut at the upper end of the throttle cable.
- Turn the adjuster until 2 – 3 mm (0.08 – 0.12 in.) of throttle grip free play is obtained.
- Tighten the locknut.

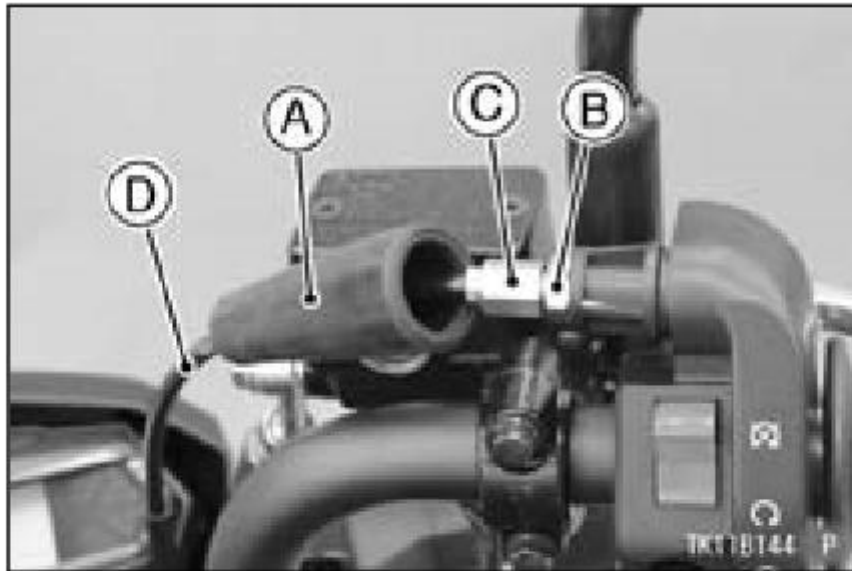

- A. Dust Cover
- B. Locknut
- C. Adjuster
- D. Throttle Cable

- Slide the dust cover to the original position.
- With the engine idling, turn the handlebars to each side. If handlebars movement changes the idle speed, the throttle cable may be improperly adjusted or incorrectly routed, or it may be damaged. Be sure to correct any of these conditions before riding.

⚠ WARNING

Operation with improperly adjusted, incorrectly routed, or damaged cable could result in an unsafe riding condition. Be sure the control cable is adjusted and routed correctly, and is free from damage.

Idle Speed

The idle speed inspection should be performed in accordance with the Periodic Maintenance Chart.

This motorcycle is equipped with the Idle Speed Control System. If the idle speed is disturbed, inspection of the idle speed control should be done by an authorized Kawasaki dealer.

Idle Speed

1 750 – 1 850 r/min (rpm)

Clutch

Clutch Operation Inspection

- Check that the clutch lever operates properly and that the inner cable slides smoothly. If there is any irregularity, have the clutch cable checked by an authorized Kawasaki dealer.
- Check the clutch lever free play as shown.

Clutch Lever Free Play

2 – 3 mm (0.08 – 0.12 in.)

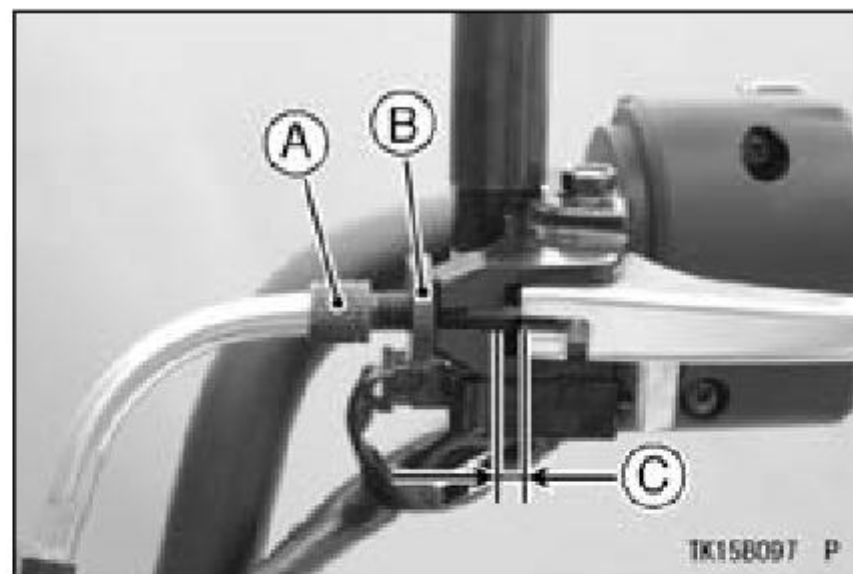

A. Adjuster

B. Locknut

C. Clutch Lever Free Play

- If the free play is incorrect, adjust the lever free play as follows.

Clutch Lever Free Play Adjustment

- Loosen the locknut at the clutch lever.
- Turn the adjuster so that the clutch lever will have the specified free play.

 **WARNING**

Excess clutch lever free play could prevent clutch disengagement and cause a crash resulting in serious injury or death. When adjusting the clutch lever free play, be sure the upper end of the clutch outer cable is fully seated in its fitting so that it doesn't slip into place later and create excessive free play.

- Tighten the locknut.
- If it cannot be done, have the clutch lever free play adjusted by an authorized Kawasaki dealer.

NOTE

- *After the adjustment is made, start the engine and check that the clutch*

does not slip and that it releases properly.

Drive Chain

Drive Chain Lubrication

Lubrication is necessary after riding through rain or on wet roads, or any time that the chain appears dry.

Use a lubricant for drive chains. If the chain is especially dirty, clean it using a cleaner for drive chains following the instructions supplied by the chain cleaner manufacturer.

- Apply lubricant to the sides of the rollers so that it will penetrate to the rollers and bushings. Wipe off any excess lubricant.

104 MAINTENANCE AND ADJUSTMENT

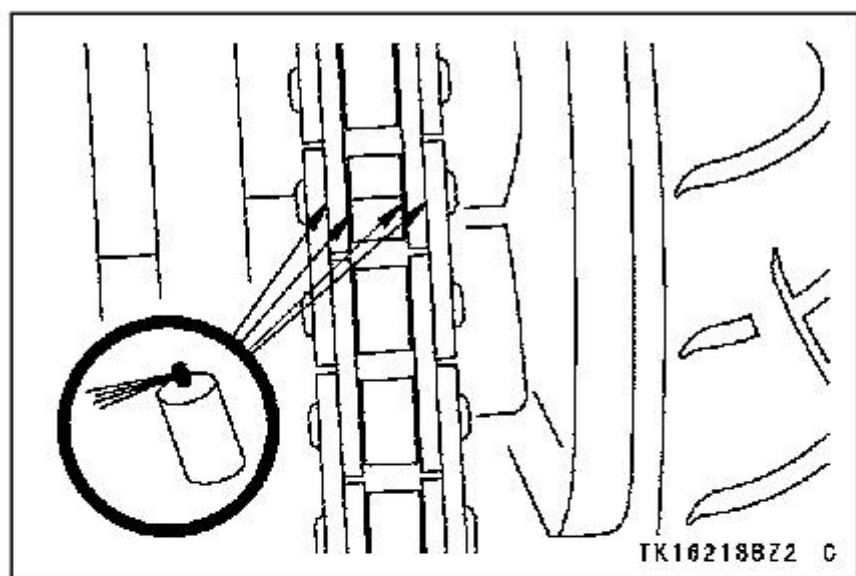

- Wipe off any lubricant that gets on the tire surface.

Drive Chain Slack Inspection

- Set the motorcycle up on its side stand.
- Clean the chain if it is dirty, and lubricate it if it appears dry.
- Rotate the rear wheel to find the position where the chain is tightest, and measure the maximum chain slack by pulling up and pushing down the

chain midway between the engine sprocket and rear wheel sprocket.

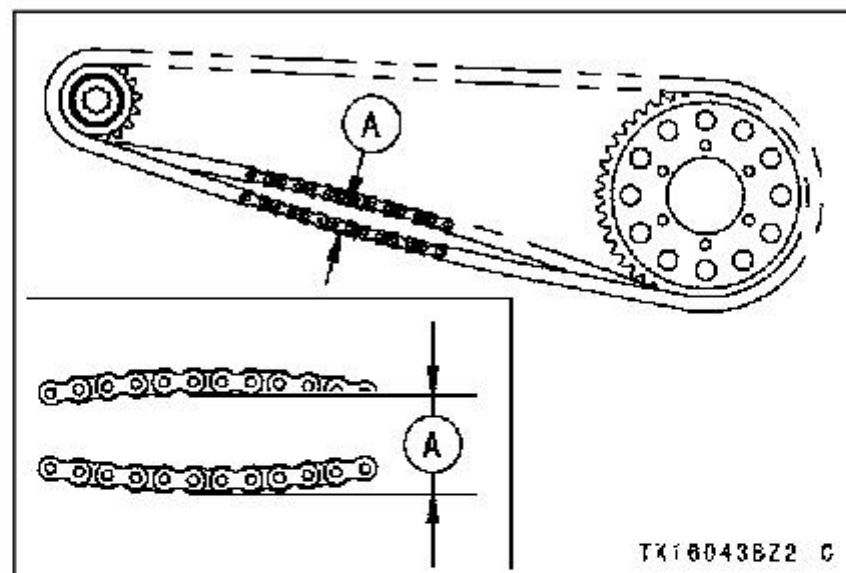

A. Chain Slack

- If the drive chain is too tight or too loose, adjust it so that the chain slack is within the standard value.

Drive Chain Slack

Standard: 15 – 30 mm (0.6 – 1.2 in.)

Drive Chain Slack Adjustment

- Remove the cotter pin, and loosen the axle nut.
- Loosen the left and right chain adjuster locknuts.

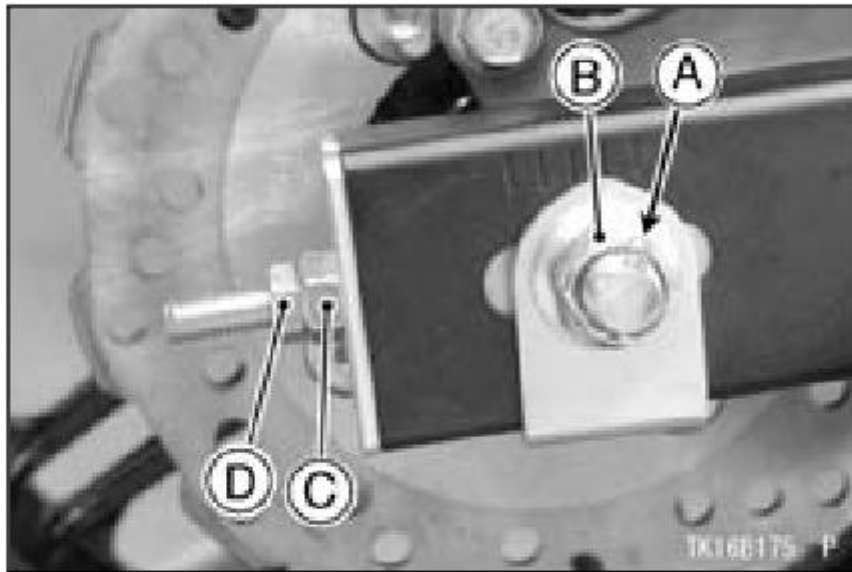

- A. Cotter Pin
- B. Axle Nut
- C. Adjusting Nut
- D. Locknut

- If the chain is too loose, turn in the left and right chain adjusting nuts evenly.
- If the chain is too tight, turn out the left and right chain adjusting nuts evenly.
- Turn both chain adjusting nuts evenly until the drive chain has the correct amount of slack. To keep the chain and wheel properly aligned, the notch on the left wheel alignment indicator should align with the same swingarm mark that the right wheel alignment indicator notch aligns with.

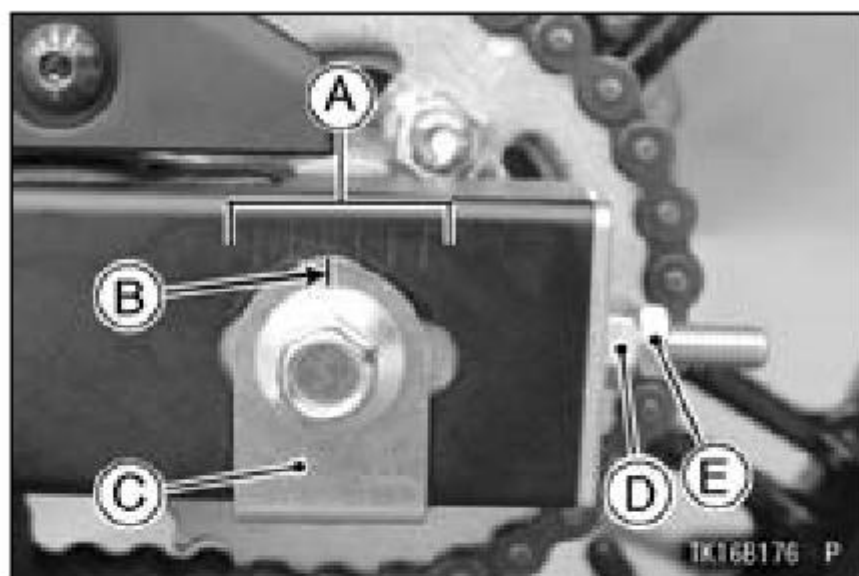

- A. Marks
- B. Notch
- C. Indicator
- D. Adjusting Nut
- E. Locknut

NOTE

- *Wheel alignment can also be checked using the straightedge or string method.*

WARNING

Misalignment of the wheel will result in abnormal wear, and may result in an unsafe riding condition. Align the rear wheel using the marks on the swingarm or measuring the distance between the center of the axle and swingarm pivot.

- Tighten both chain adjuster locknuts.
- Tighten the axle nut to the specified torque.

Tightening Torque

Axle Nut:
64 N·m (6.5 kgf·m, 47 ft·lb)

NOTE

- *If a torque wrench is not available, this item should be serviced by an authorized Kawasaki dealer.*

- Rotate the wheel, measure the chain slack again at the tightest position, and readjust if necessary.
- Install a new cotter pin through the axle, and spread its ends.

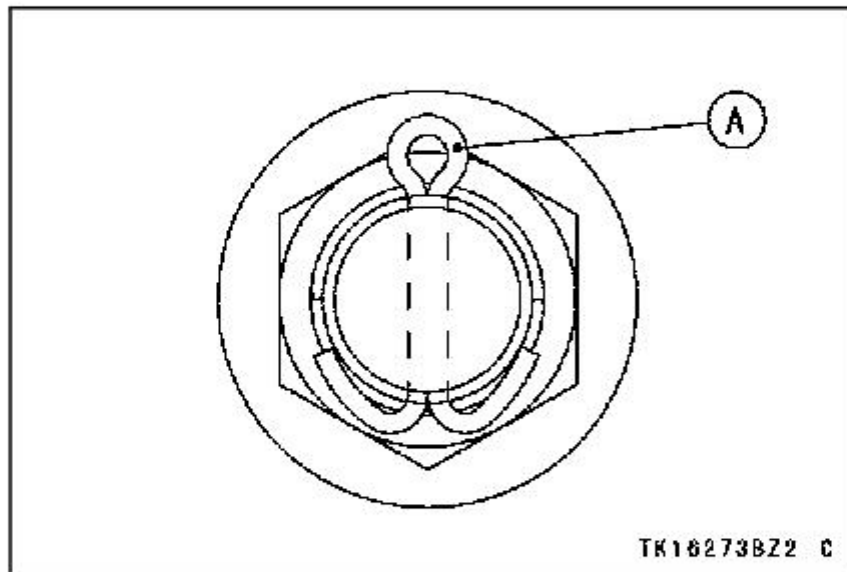

A. Cotter Pin

⚠ WARNING

A loose axle nut can lead to an accident resulting in serious injury or death. Tighten the axle nut to the proper torque and install a new cotter pin.

- Check the rear brake (see Brakes section in this chapter).

Brakes

If you feel there is something wrong when applying the brakes, have the brake system checked by an authorized Kawasaki dealer immediately.

 **WARNING**

Air in the brake lines diminish braking performance and can cause an accident resulting in injury or death. If the brake lever or pedal feels mushy when it is applied, there might be air in the brake lines or the brake may be defective. Have the brake checked immediately by an authorized Kawasaki dealer.

Brake Fluid Level Inspection

- With the front brake fluid reservoir held horizontal, the brake fluid level must be above the lower level line.

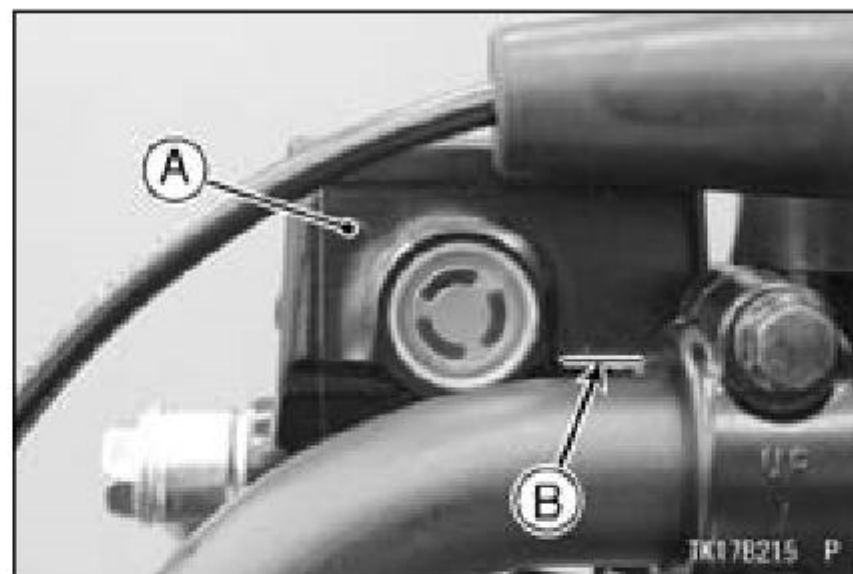

A. Front Brake Fluid Reservoir
B. Lower Level Line

- With the rear brake fluid reservoir held horizontal, the brake fluid level in the rear brake fluid reservoir must be kept between the upper and lower level lines.

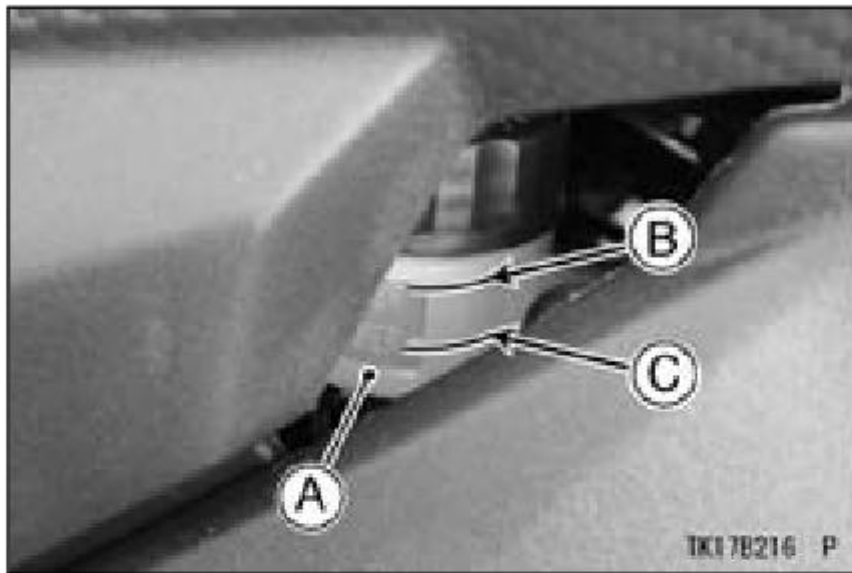

A. Rear Brake Fluid Reservoir
B. Upper Level Line
C. Lower Level Line

- If the fluid level is lower than the lower level line it may indicate that the fluid is leaking. In this case, have the brake system inspected by an authorized Kawasaki dealer.

Brake Pad Wear Inspection

Inspect the brakes for wear. For each front and rear disc brake caliper, if the

thickness of either pad lining is less than 1 mm (0.04 in.), replace both pads in the caliper as a set. Pad replacement should be done by an authorized Kawasaki dealer.

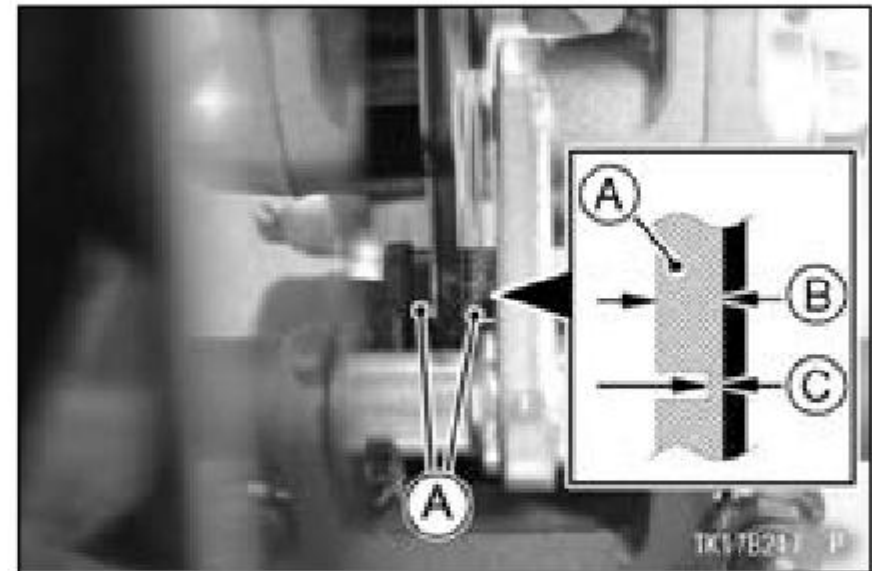

A. Front Brake Pads
B. Lining Thickness
C. 1 mm (0.04 in.)

110 MAINTENANCE AND ADJUSTMENT

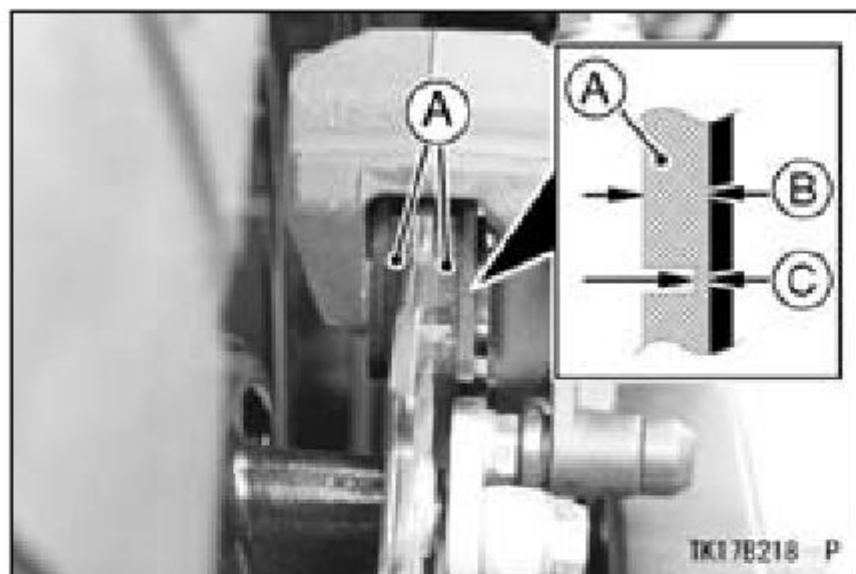

- A. Rear Brake Pads
- B. Lining Thickness
- C. 1 mm (0.04 in.)

Brake Light Switches

Brake Light Switch Inspection

- Turn the ignition switch on.
- The brake light should go on when the front brake is applied.

- If it does not, ask your authorized Kawasaki dealer to inspect the front brake light switch.
- Check the operation of the rear brake light switch by depressing the brake pedal. The brake light should go on after the proper pedal travel.

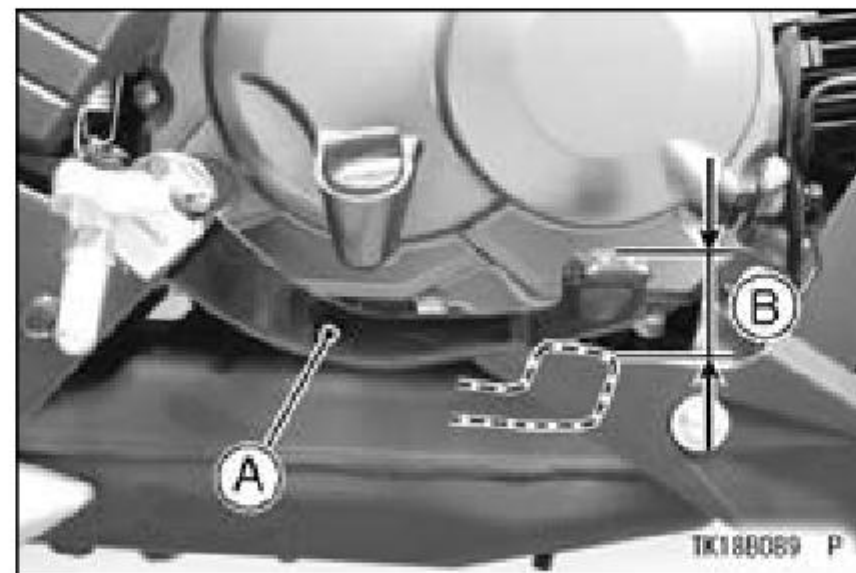

- A. Brake Pedal
- B. 10 mm (0.39 in.)

- If the light does not come on, adjust the rear brake light switch.

Brake Pedal Travel

10 mm (0.39 in.)

Brake Light Switch Adjustment

- To adjust the rear brake light switch, move the switch up or down by turning the adjusting nut.

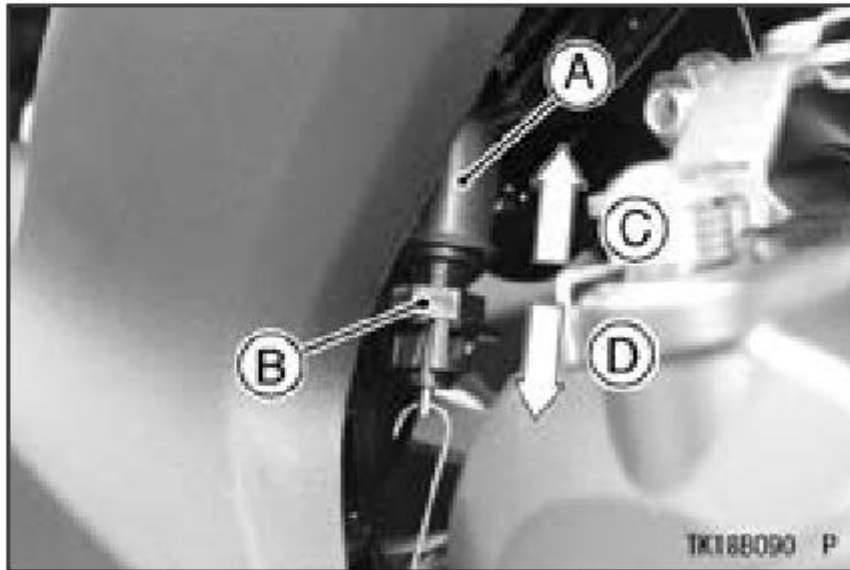

- A. Rear Brake Light Switch
- B. Adjusting Nut
- C. Lights sooner
- D. Lights later

NOTICE

To avoid damaging the electrical connections inside the switch, be sure that the switch body does not turn during adjustment.

Suspension System

Front Fork

NOTICE

After riding on the normal road, the unpaved road and in the rainy weather, clean off any dirt (grit, mud or insect etc.) that stuck to inner tube before it hardens. If the motorcycle keeps running with the dirt stuck to the inner tube, the oil seal will be damaged and it causes the oil leak.

Rear Shock Absorber

Spring Preload Adjustment

The spring preload adjuster on the rear shock absorber has 4 positions.

Standard

2nd position

- If the spring action feels too soft or too stiff, have it adjusted by an authorized Kawasaki dealer.

Setting Table

Rear Shock Absorber Spring Preload Setting

	Softest setting limit	Standard	Hardest setting limit
Adjuster Position	1st	2nd	4th
Spring Action	Weak	←→	Strong
Setting	Soft	←→	Hard
Load	Light	←→	Heavy
Road	Good	←→	Bad
Speed	Low	←→	High

Wheels

Tire Pressure Inspection

- Remove the air valve cap.
- Check the tire pressure often, using an accurate gauge.
- Make sure to install the air valve cap securely.

NOTE

- *Measure the tire pressure when the tires are cold (that is, when the motorcycle has not been ridden more than 1.6 km (1 mile) during the past 3 hours).*
- *Tire pressure is affected by changes in ambient temperature and altitude, and so the tire pressure should be checked and adjusted when your riding involves wide variations in temperature or altitude.*



A. Tire Pressure Gauge

Tire Air Pressure (when cold)

Front	150 kPa (1.50 kgf/cm ² , 22 psi)
Rear	200 kPa (2.00 kgf/cm ² , 29 psi)

Tire Wear, Damage

As the tire tread wears down, the tire becomes more susceptible to puncture and failure. An accepted estimate is that 90% of all tire failures occur during the last 10% of tread life (90% worn).

So it is false economy and unsafe to use the tires until they are bald.

Tire Wear Inspection

- Measure the depth of the tread with a depth gauge, and replace any tire that has worn down to the minimum allowable tread depth.

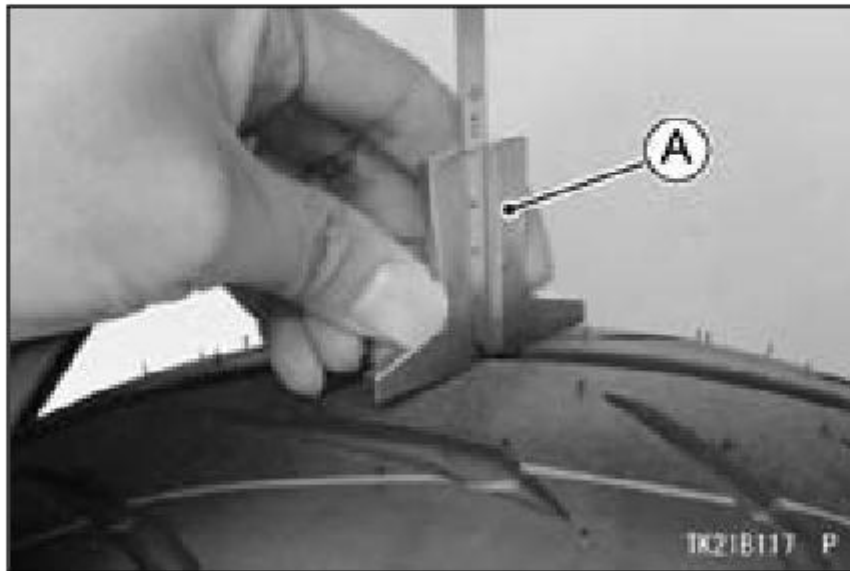

A. Tire Depth Gauge

Minimum Tread Depth

Front	—	1 mm (0.04 in.)
Rear	Under 130 km/h (80 mph)	2 mm (0.08 in.)
	Over 130 km/h (80 mph)	3 mm (0.12 in.)

- Visually inspect the tire for cracks and cuts, replacing the tire in case of bad damage. Swelling or high spots indicate internal damage, requiring tire replacement.

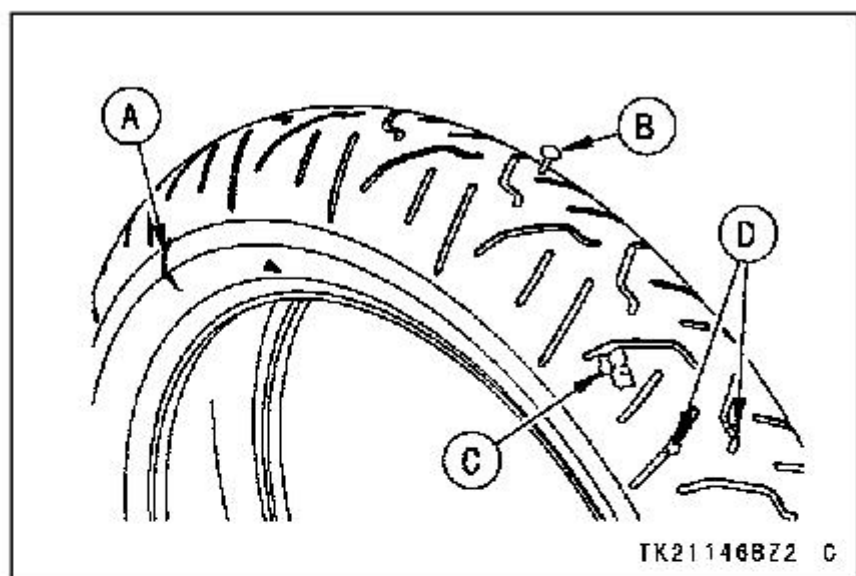

- A. Crack or Cut
- B. Nail
- C. Swelling or High Spot
- D. Stone

- Remove any imbedded stones or other foreign particles from the tread.

⚠ WARNING

Tires that have been punctured and repaired do not have the same capabilities as undamaged tires and can suddenly fail, causing an accident resulting in serious injury or death. Replace damaged tires as soon as possible. To ensure safe handling and stability, use only the recommended standard tires for replacement, inflated to the standard pressure. If it is necessary to ride on a repaired tire, do not exceed 100 km/h (60 mph) until the tire is replaced.

NOTE

- *Most countries may have their own regulations requiring a minimum tire tread depth; be sure to follow them.*

- *When operating on public roadways, keep maximum speed under traffic law limits.*

Standard Tire (Tubeless)

Front	Make, Type: IRC, NR77U Size: 100/90-12 49J
Rear	Make, Type: IRC, NR77U Size: 120/70-12 51L

 **WARNING**

Mixing tire brands and types can adversely affect handling and cause an accident resulting in injury or death. Always use the same manufacturer's tires on both front and rear wheels.

 **WARNING**

New tires are slippery and may cause loss of control and injury. A break-in period of 160 km (100 miles) is necessary to establish normal tire traction. During break-in, avoid sudden and maximum braking and acceleration, and hard cornering.

Battery

The battery installed in this motorcycle is a sealed type, so it is not necessary to check the battery electrolyte level or add distilled water.

NOTICE

Never remove the sealing strip, or the battery can be damaged. Do not install a conventional battery in this motorcycle, or the electrical system cannot work properly.

Make	Siam Furukawa
Type	FTH4L-BS

Battery Maintenance

It is the owner's responsibility to keep the battery fully charged. Failure to do so can lead to battery failure and leave you stranded.

If you are riding your vehicle infrequently, inspect the battery voltage weekly using a voltmeter. If it drops below 12.6 volts, the battery should be charged using an appropriate charger (check with your Kawasaki dealer).

If you will not be using the motorcycle for longer than two weeks, the battery should be charged using an appropriate charger. Do not use an automotive-type quick charger that may overcharge the battery and damage it.

NOTE

○ *Leaving the battery connected causes the electrical components (clock etc.) to make the battery discharged, resulting the over discharge of the battery. In this case, the repair or replacement of the battery is not included in the warranty. If you do not drive for four weeks or more, disconnect the battery from the vehicle.*

Kawasaki-recommended chargers are:

Battery Mate 150-9

OptiMate 4

Yuasa MB-2040/2060

Christie C10122S

If the above chargers are not available, use equivalent one.

For more details, ask your Kawasaki dealer.

Battery Charging

- Charge the battery following the instructions of your battery charger.
- The charger will keep the battery fully charged until you are ready to re-install the battery in the motorcycle (see Battery Installation).

⚠ DANGER

- **Battery acid generates hydrogen gas which is flammable and explosive under certain conditions. It is present within a battery at all times, even in a discharged condition. Keep all flames and sparks (cigarettes) away from the battery.**
- **Wear eye protection when working with a battery. In the event of battery acid contact with skin, eyes, or clothing, wash the affected areas immediately with water for at least five minutes. Seek medical attention.**

Battery Removal

- Make sure the ignition switch is turned off.

120 MAINTENANCE AND ADJUSTMENT

- Remove the seat. Refer to the Seat section in the GENERAL INFORMATION chapter.
- Slide the transparent cap from the negative (-) terminal.
- Disconnect the negative (-) cable from the negative (-) terminal.
- Slide the red cap from the positive (+) terminal.
- Disconnect the positive (+) cable from the positive (+) terminal.
- Take the battery out of the rear fender.

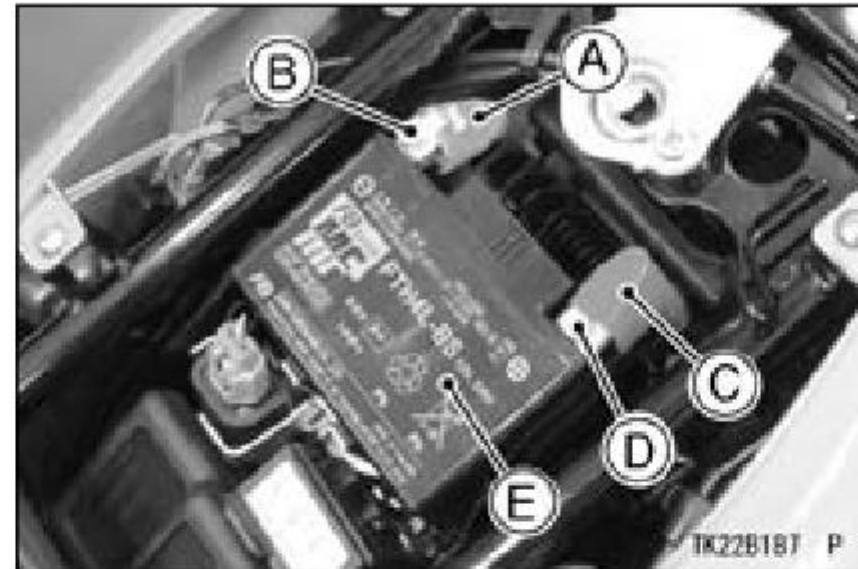

- A. Transparent Cap
- B. Negative (-) Terminal
- C. Red Cap
- D. Positive (+) Terminal
- E. Battery

- Clean the battery using a solution of baking soda and water. Be sure that the cable connections are clean.

Battery Installation

- Place the battery on the rear fender.

- Connect the positive (+) cable to the positive (+) terminal, and then connect the negative (–) cable to the negative (–) terminal.

NOTE

- *When connecting the battery negative (–) cable, be sure to tighten the terminal bolt while pressing the battery cable terminal against the battery terminal.*

NOTICE

Installing the negative (–) cable to the positive (+) terminal of the battery or the positive (+) cable to the negative (–) terminal of the battery can seriously damage the electrical system.

- Put a light coat of grease on the terminals to prevent corrosion.

- Cover each terminal with each cap.
- Install the seat. Refer to the Seat section in the GENERAL INFORMATION chapter.

Headlight

Headlight aiming should be done by an authorized Kawasaki dealer.

Horizontal Adjustment

The headlight beam is adjustable horizontally. If not properly adjusted horizontally, the beam will point to one side rather than straight ahead.

- Using the phillips tip screwdriver from the tool kit, turn the horizontal adjuster in or out until the beam points straight ahead.

122 MAINTENANCE AND ADJUSTMENT

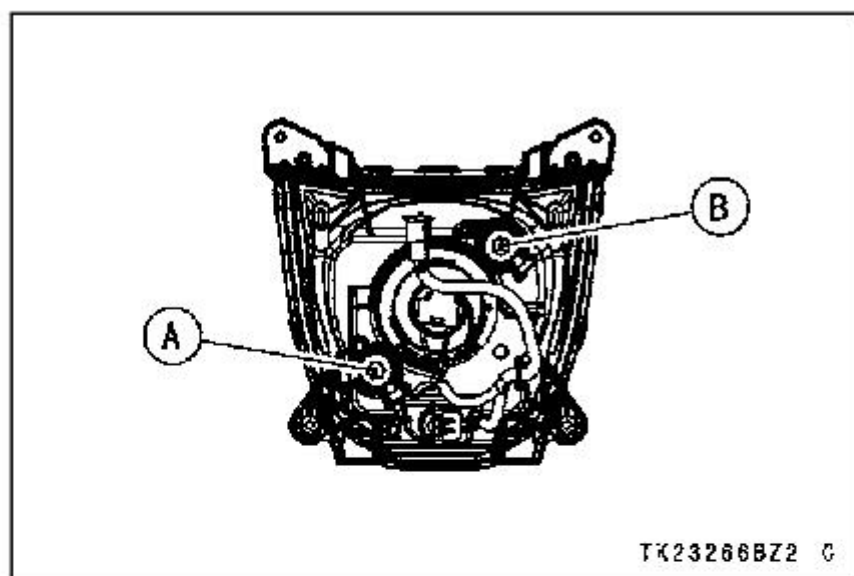

- A. Horizontal Adjuster
- B. Vertical Adjuster

Vertical Adjustment

The headlight beam is adjustable vertically. If adjusted too low, neither low nor high beam will illuminate the road far enough ahead. If adjusted too high,

the high beam will fail to illuminate the road close ahead, and the low beam will blind oncoming drivers.

- Using the phillips tip screwdriver from the tool kit, turn the vertical adjuster in or out to adjust the headlight vertically.

NOTE

- *On high beam, the brightest points should be slightly below horizontal. The proper angle is 0.4 degrees below horizontal. This is a 50 mm (2.0 in.) drop at 7.6 m (25 ft) measured from the center of the headlight, with the motorcycle on its wheels and the rider seated.*

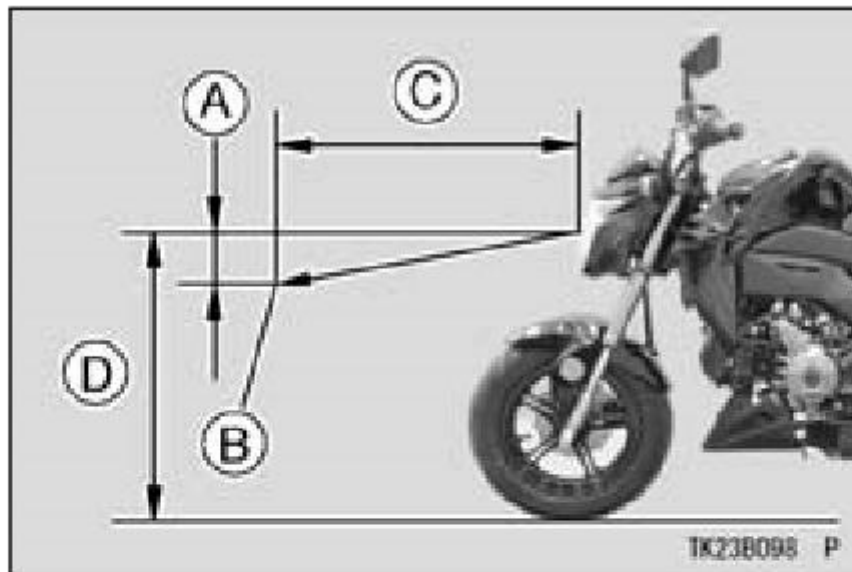

- A. 50 mm (2.0 in.)
- B. Center of Brightest Spot
- C. 7.6 m (25 ft)
- D. Height of Headlight Center

Fuses

Fuses are arranged in the fuse box located under the seat. If a fuse fails during operation, inspect the electrical system to determine the cause, and

then replace it with a new fuse of proper amperage.

If the fuse fails repeatedly, there is something wrong with the electrical system. Have the motorcycle checked by an authorized Kawasaki dealer.

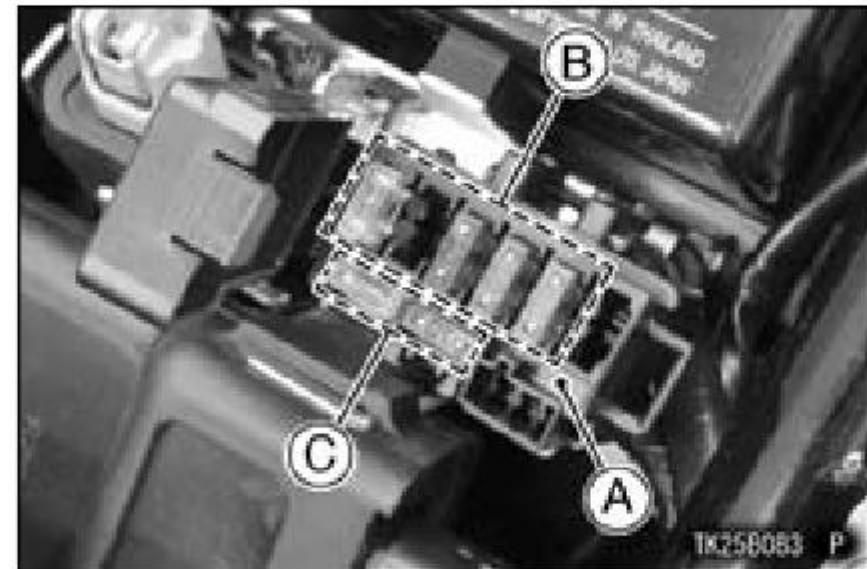

- A. Fuse Box
- B. Fuses
- C. Spare Fuses

WARNING

Substituting fuses can cause wiring to overheat, catch fire and/or fail. Do not use any substitute for the standard fuse. Replace the blown fuse with a new one of the correct capacity, as specified on the fuse box.

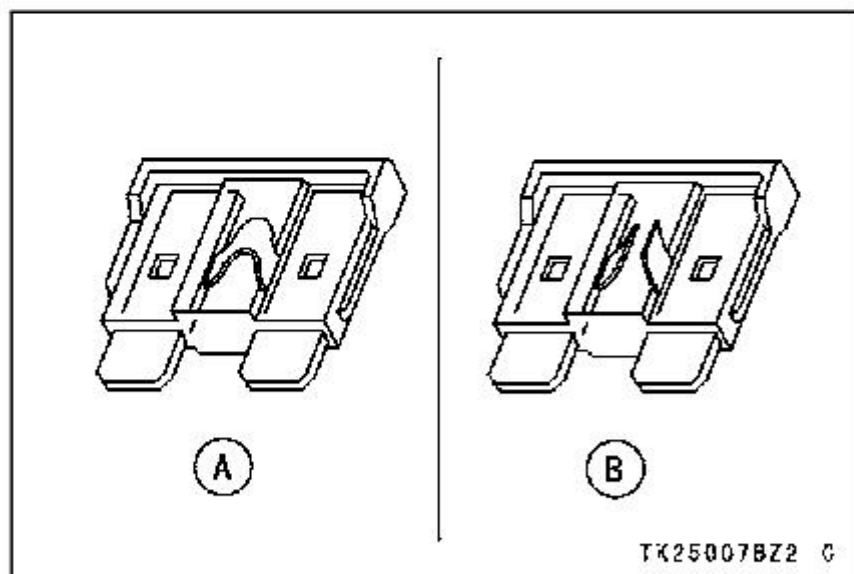

A. Normal
B. Failed

General Lubrication

Lubricate the points shown below, with either engine oil or regular grease, in accordance with the Periodic Maintenance Chart or whenever the vehicle has been operated under wet or rainy conditions.

Before lubricating each part, clean off any rusty spots with rust remover and wipe off any grease, oil, dirt, or grime.

Apply motor oil to the following pivots

- Side Stand
- Clutch Lever
- Front Brake Lever
- Rear Brake Pedal

Lubricate the following cables with a pressure cable luber

- (K) Clutch Inner Cable
- (K) Throttle Inner Cable

Apply grease to the following points

- **(K)** Clutch Inner Cable Upper End
- **(K)** Throttle Inner Cable Upper End

(K): Should be serviced by an authorized Kawasaki dealer.

NOTE

- *After connecting the cables, adjust them.*

Cleaning

General Precautions

Frequent and proper care of your vehicle will enhance its appearance, optimize overall performance, and extend its useful life. Covering your vehicle with a high quality, breathable vehicle cover will help protect its finish from harmful UV rays, pollutants, and reduce the amount of dust reaching its surfaces.

**WARNING**

Build-up of debris or flammable material in and around the vehicle chassis, engine, and exhaust can cause mechanical problems and increase the risk of fire. When operating the vehicle in conditions that allow debris or flammable material to collect in and around the vehicle, inspect the engine, electrical component and exhaust areas frequently. If debris or flammable materials have collected, park the vehicle outside and stop the engine. Allow the engine to cool, then remove any collected debris. Do not park or store the vehicle in an enclosed space prior to inspecting for build-up of debris or flammable materials.

- Be sure the engine and exhaust are cool before washing.
- When washing the vehicle, always use a mild neutral detergent and water.
- Avoid applying all harsh chemicals, solvents, degreaser, oil remover, electrical contact cleaner, and household cleaning products such as ammonia-based window cleaners. They will damage or deteriorate painted parts, plastic parts, rubber parts and other synthetic parts including covers and headlight lens.
- Avoid applying degreaser to seals, brake pads, and tires.
- Gasoline, and brake fluid will damage the finish of painted and plastic surfaces: wash them off immediately.
- Avoid wire brushes, steel wool, and all other abrasive pads or brushes.

- Take care when washing the headlight lens and other plastic parts as they can easily be scratched.

NOTE

- *After riding in an area where the roads are salted or near the ocean, immediately wash your vehicle with cold water. Do not use warm water as it accelerates the chemical reaction of the salt. After drying, apply a corrosion protection spray on all metal and chrome surfaces to prevent corrosion.*
- *Condensation may form on the inside of the headlight lens after riding in the rain, washing the vehicle or humid weather. To remove the moisture, start the engine and turn on the*

headlight. Gradually the condensation on the inside of the lens will clear off.

Matte Paint Parts

- When washing the vehicle, always use a mild neutral detergent and water, or cleaners for matte paint.
- The matte paint effect may be lost when the paint is excessively rubbed.
- If any doubt, consult an authorized Kawasaki dealer.

Plastic Parts

After washing, use a soft cloth to gently dry plastic parts. When dry, treat the headlight lens and other non-painted plastic parts with an approved plastic cleaner/polisher product.

NOTICE

Plastic parts may deteriorate and break if they come in contact with chemical substances or household cleaning products such as gasoline, brake fluid, window cleaners, thread-locking agents, or other harsh chemicals. If a plastic part comes in contact with any harsh chemical substance, wash it off immediately with water and a mild neutral detergent, and then inspect for damage. Avoid using abrasive pads or brushes to clean plastic parts, as they will damage the part's finish.

Chrome and Aluminum

Chrome and uncoated aluminum parts can be treated with a chrome/aluminum polish. Coated aluminum

should be washed with a mild neutral detergent and finished with a spray polish. Aluminum wheels, both painted and unpainted can be cleaned with special non-acid based wheel spray cleaners.

Leather, Vinyl, and Rubber

If your vehicle has leather accessories, special care must be taken. Use a leather cleaner/treatment to clean and care for leather accessories. Washing leather parts with detergent and water will damage them, shortening their life.

Vinyl parts should be washed with the rest of the vehicle, then treated with a vinyl treatment.

The sidewalls of tires and other rubber components should be treated with a rubber protectant to help prolong their useful life.

Where to be Careful

Avoid spraying water with any great force near the following places.

- Disc brake master cylinder and caliper.
- Under the seat - if water gets into the fuse box or battery, it can ground out the spark. When this happens the vehicle will not operate properly and the affected parts must be wiped dry.

NOTICE

Coin operated, high pressure spray washers are not recommended. Water may be forced into bearings and other components causing eventual failure from rust and corrosion. Some soaps are highly alkaline and may leave a residue or cause spotting.

NOTE

- *Abrasive cleanser or high pressure washer will damage the surface finish on the bodywork.*

Washing Your Vehicle

- Before washing, precautions must be taken to keep water off the following parts.

130 MAINTENANCE AND ADJUSTMENT

Muffler rear opening - cover with a plastic bag.

Ignition switch - cover the keyhole with tape.

- Rinse your vehicle with cold water from a garden hose to remove any loose dirt.
- Mix a mild neutral detergent (designed for motorcycles or automobiles) and water in a bucket. Use a soft cloth or sponge to wash your vehicle.
- After washing, rinse your vehicle thoroughly with clean water to remove any residue (residue from the

detergent can damage parts of your vehicle).

- Remove the plastic bag and tape.
- Use a soft cloth to dry your vehicle. As you dry, inspect your vehicle for chips and scratches. Do not let the water air dry as this can damage the painted surfaces.
- Carefully ride your vehicle at a slow speed and apply the brakes several times. This helps dry the brakes and restores them to normal operating performance.

APPENDIX

Storage

Whenever your motorcycle will not be in use for a long period, proper storage is essential.

It consists of checking and replacing missing or worn parts; lubricating parts to ensure that they do not corrode and, in general, preparing the motorcycle so that when the time comes to use it again, it will be in top condition.

See your authorized Kawasaki dealer for this service or do the following.

Preparation for Storage

Make sure the area is well ventilated and free from any source of flame.

DANGER

Exhaust gas contains carbon monoxide, a colorless, odorless poisonous gas. Inhaling carbon monoxide can cause serious brain injury or death. DO NOT run the engine in enclosed areas. Operate only in a well-ventilated area.

 **WARNING**

Gasoline is extremely flammable and can be explosive under certain conditions, creating the potential for serious burns.

- Turn the ignition key off.
- Do not smoke.
- Make sure the area is well ventilated and free from any source of flame or sparks; this includes any appliance with a pilot light.

 **WARNING**

Gasoline is a toxic substance. Dispose of gasoline properly. Contact your local authorities for approved disposal methods.

- Clean the entire vehicle thoroughly.
- Run the engine for about five minutes to warm the oil, shut it off, and drain the engine oil. (see Engine Oil section in the MAINTENANCE AND ADJUSTMENT chapter)

 **WARNING**

Engine oil is a toxic substance. Dispose of used oil properly. Contact your local authorities for approved disposal methods or possible recycling.

- Put in fresh engine oil.
- Empty the fuel from the fuel tank using a pump or syphon.
- Remove the spark plug and add fogging oil into the combustion chamber. If the spark plug cannot be removed, take the motorcycle to an authorized Kawasaki dealer.
- Set the motorcycle on a stand so that both wheels are raised off the ground. (If this cannot be done, put boards under the front and rear wheels to keep dampness away from the tire rubber.)
- Spray oil on all unpainted metal surfaces to prevent rusting. Avoid getting oil on rubber parts or in the brakes.
- Lubricate the drive chain and all the cables.
- Remove the battery, and store it where it will not be exposed to direct sunlight, moisture, or freezing temperatures. During storage it should be given a slow charge (one ampere or less) about once a month. Keep the battery well charged especially during cold weather.
- Tie plastic bag over the muffler to prevent moisture from entering.
- Put a cover over the motorcycle to keep dust and dirt from collecting on it.

Preparation after Storage

- Remove the plastic bag from the muffler.
- Charge the battery if necessary and install the battery in the motorcycle.
- Fill the fuel tank with fresh fuel.
- Check all the points listed in the Daily Checks section.
- Lubricate the pivots, bolts, and nuts.

Troubleshooting Guide

If any warning indicators go on or blink, see the General Information for proper action. The following trouble shooting guide may also help you in case you experience any of the listed problems. If these checks don't help you to solve the situation, consult an authorised Kawasaki dealer.

If the starter turns but the engine does not start:

- Try turning the ignition key off and on again.
- Check the fuel level in the tank.
- Try refilling with fresh fuel if the vehicle has been stored for a while.
- Check the battery voltage.

If the starter does not turn:

- Check the ignition key is switched on.

- Check the engine stop switch.
- Check the transmission is in neutral.
- Check the battery voltage.
- Check the battery terminals are tightly attached.
- Check the fuse.

If the engine stalls:

- Check the clutch is engaged/disengaged correctly.
- Check the side stand is up.
- Check the engine is warmed up enough.
- Check the fuel level in the tank.
- Try refilling with fresh fuel if the vehicle has been stored for a while.
- Check the idling speed is not too low.



Your Warranty/Owner Satisfaction

Welcome to the Kawasaki family!

Congratulations on buying your Kawasaki vehicle. You've chosen a great, high-quality product with state-of-the-art features and built to Kawasaki's high standards. Your satisfaction is important to your authorized Kawasaki dealer and to Canadian Kawasaki Motors Inc. Here is some important information regarding your vehicle's limited warranty.

Frequently Asked Questions

What is a Limited Warranty?

The most important thing to know about your warranty is that it protects you from manufacturing defects in material or workmanship during the warranty period. You can find the warranty period in the Kawasaki Limited Warranty Certificate your Kawasaki dealer provided to you at the time of sale. The warranty does not cover the cost of regularly-scheduled maintenance. The warranty also does not apply to the normal wear of items such as tires, brake pads, transmission drive belts, chains, sprockets, etc.

What is the Kawasaki Protection Plus?

Much of the warranty coverage offered by the limited warranty can be extended by purchasing the Kawasaki Protection Plus (KPP). See your Kawasaki dealer or go to Kawasaki.com for more information if you don't already have the KPP.

What Am I Responsible For?

You are responsible for maintaining your vehicle according to the maintenance schedule shown in this owner's manual.

You are responsible for notifying your dealer immediately if there is a problem, and you, as the owner, will need to authorize the dealer to inspect the unit.

You will be responsible for paying for routine maintenance, including the first scheduled service. You can have the required servicing done by your Kawasaki dealer (recommended) or an equally-qualified service facility. You can also do your own maintenance work if you have the proper tools, service references, and mechanical skills. However, if a failure is found to be caused by improper servicing, it would not be covered by the limited warranty.

You may purchase a Kawasaki Service Manual and any necessary special tools directly from your Kawasaki dealer.

You will be responsible for paying for repairs needed because of an accident, to replace worn parts such as tires, chains, brakes, and for repairs needed because of a lack of maintenance, misuse or racing.

Whether you do it yourself or take your vehicle to a Kawasaki dealer, be sure to record your service in the Maintenance Record section of this Owner's Manual. Keep all receipts for the service and/or items necessary to perform the maintenance so that in the event of a failure you can document the service history.

What Are The Dealership's Responsibilities?

Your Kawasaki dealer offers a wide range of services, parts, accessories, and information on your product and on Kawasaki.

Each dealer is independently owned and operated and is responsible for the dealership's operations, its repair, warranty, and service work, and its personnel.

Your dealer is responsible for completing the set up and pre-delivery service of your new Kawasaki vehicle. The dealership should also explain its operation, maintenance, and warranty provisions so you understand them at the time of purchase or at any other time you have questions.

The dealership is responsible for inspecting your Kawasaki vehicle if there is a failure, investigating the cause of the problem, and getting any needed authorization from Kawasaki if the repair is one that will be covered by the limited warranty. The dealership will also file all necessary paperwork. The dealership is responsible for correctly completing any necessary repairs, whether they are covered by the limited warranty or not.

How Do I Get Warranty Service?

If there is a problem with your vehicle within the limited warranty period, you will need to schedule a service appointment and provide any maintenance records to an authorized Kawasaki dealer for inspection and diagnosis. You can go to any Kawasaki dealer for warranty repairs. Your Kawasaki dealer will inspect your vehicle and give you the results of the inspection. The dealer will perform the repairs at no cost to you if it is determined that the problem is covered by the warranty.

Kawasaki will work with your dealer to resolve any warranty issues. No authorization for warranty work can be given until your vehicle has been inspected by a Kawasaki dealer.

What if I am not Satisfied With My Warranty Service?

If you aren't satisfied with your dealership's repair work or operations, it is best to discuss the situation with the appropriate dealership manager. If you have already done this, then contact the dealership's owner or general manager to request a review of the issue.

If you are unable to resolve a problem after consulting with the dealership management and need further assistance, contact Canadian Kawasaki Motors Inc. at the address below. Please be certain to provide the model, vehicle identification number (VIN), mileage or hours of use, accessories, dates that events occurred

and what action has been taken by both you and your dealer. Include the name and address of the dealership. To assist us in resolving your inquiry, please include copies of related receipts and any other pertinent information including the name of the dealership personnel with whom you have been working. Upon receipt of your correspondence, Canadian Kawasaki Motors Inc. will contact the dealership and work with it in resolving your problem.

Want to Contact Kawasaki?

This owner's manual should answer most of your questions about your Kawasaki. Your Kawasaki dealer should either be able to answer any other questions you might have immediately or be able to find the answer for you.

Please send your correspondence to:
Consumer Services
Canadian Kawasaki Motors Inc.
101 Thermos Road
Toronto, Ontario
M1L 4W8
(416) 445-7775

Reporting Safety Defects

(For Products Sold in the United States of America, District of Columbia, and U.S. Territories Only)

If you believe that your vehicle has a defect which could cause a crash or could cause injury or death, you should immediately inform the National Highway Traffic Safety Administration (NHTSA) in addition to notifying Kawasaki Motors Corporation, U.S.A.

If NHTSA receives similar complaints, it may open an investigation, and if it finds that a safety defect exists in a group of vehicles, it may order a recall and remedy campaign. However, NHTSA cannot become involved in individual problems between you, your dealer, or Kawasaki Motors Corporation, U.S.A.

To contact NHTSA, you may either call the Auto Safety Hotline toll-free at 1-800-424-9393 (or 366-0123 in Washington, D.C. area) or write to: NHTSA, U.S. Department of Transportation, Washington, D.C. 20590. You can also obtain other information about motor vehicle safety from the Hotline.

Environmental Protection

To help preserve the environment, properly discard used batteries, tires, oils and fluids, or other vehicle components that you might dispose of in the future. Consult your authorized Kawasaki dealer or local environmental waste agency for their proper disposal procedure. This also applies to disposal of the entire vehicle at the end of its life.

Location of DFI System Diagnostic Connector

The DFI system diagnostic connector is located under the seat.

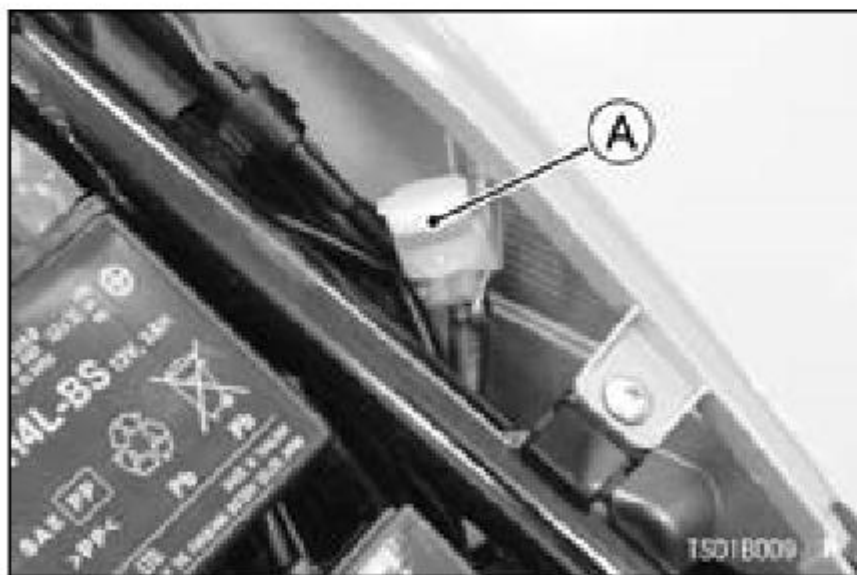

A. DFI System Diagnostic Connector

Vehicle Data Recordings

This vehicle's ECU stores certain data to assist in problem diagnosis, and for other purposes such as periodic technical inspection, regulatory compliance, and research and development.

Although the recorded data varies according to the vehicle model and region, the main information types are as follows:

- Data about the vehicle's status and settings.
- Performance of the engine and electric control equipment on the engine and chassis.
- Information related to the fuel injection system and emissions.

The vehicle's ECU does not record conversations or images.

This data can only be collected when the Kawasaki special diagnostic tool is connected to the vehicle, such as when maintenance checks or other service procedures are performed.

The acquired information will not be disclosed to a third party except in following cases:

- With the consent of the vehicle owner or user
- In case of a legal request by a government agency or judicial body

144 APPENDIX

- For various research purposes using processed information that do not identify the vehicle owner, user, or individual vehicle.



MAINTENANCE RECORD

Owner Name.....

Address

Phone Number

Engine Number

Vehicle Number.....

Key Code

Selling Dealer Name

Phone Number

Warranty Start Date

Note: Keep this information and a spare key in a secure location.

Date	Odometer Reading	Maintenance Performed	Dealer Name	Dealer Address

146 MAINTENANCE RECORD

Date	Odometer Reading	Maintenance Performed	Dealer Name	Dealer Address



MAINTENANCE RECORD 147

Date	Odometer Reading	Maintenance Performed	Dealer Name	Dealer Address



148 MAINTENANCE RECORD

Date	Odometer Reading	Maintenance Performed	Dealer Name	Dealer Address



MAINTENANCE RECORD 149

Date	Odometer Reading	Maintenance Performed	Dealer Name	Dealer Address

